

Conext™ MPPT 60 150 Solar Charge Controller (865-1030-1)

Installation and Owner's Guide

975-0400-01-01 Revision G

May 2015

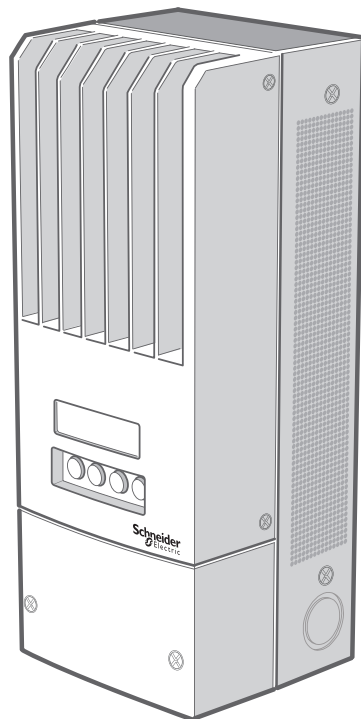

Conext™ MPPT 60 150 Solar Charge Controller

Installation and Owner's Guide

About This Guide

Purpose

The purpose of this Guide is to provide explanations and procedures for installing, configuring, operating, and troubleshooting the Conext MPPT Solar Charge Controller (solar charge controller).

Scope

This Guide provides safety guidelines, detailed planning and setup information, procedures for installing the unit, as well as information about operating and troubleshooting the unit. It does not provide details about particular brands of photovoltaic (PV) panels. You need to consult individual PV manufacturers for this information.

Audience

This Guide does not provide sufficient information for anyone but a qualified installer to install this product. Installers should be electricians or technicians fully educated on the hazards of installing electrical equipment. The monitoring and operation information in this manual is intended for anyone who needs to operate the solar charge controller.

Organization

This Guide is organized into five chapters and four appendices.

Chapter 1 describes features and functions of the Conext MPPT Solar Charge Controller.

Chapter 2 contains information and procedures to install the Conext MPPT Solar Charge Controller.

Chapter 3 contains information and procedures to configure the Conext MPPT Solar Charge Controller.

Chapter 4 contains information about the operation of the Conext MPPT Solar Charge Controller.

Chapter 5 contains information about identifying and resolving possible problems with systems using a Conext MPPT Solar Charge Controller.

Appendix A provides the specifications for the Conext MPPT Solar Charge Controller.

Appendix B is a guide to the Conext System Control Panel monitoring and configuration menus for the Conext Solar Charge Controller.

Appendix C provides information on boost charging for flooded lead-acid batteries in off-grid applications.

Abbreviations and Acronyms

CEC	Canadian Electric Code
CSA	Canadian Standards Association
DC	Direct Current
FCC	Federal Communications Commission
GFP	Ground Fault Protection
I_{MP}	Current at maximum power per STC
I_{SC}	Short circuit current rating of an PV panel under STC
LCD	Liquid Crystal Display
LED	Light Emitting Diode
MPP	Maximum Power Point
MPPT	Maximum Power Point Tracking
MSDS	Material Safety Data Sheet
NFPA	National Fire Protection Association
PDP	Conext Power Distribution Panel
PV	Photovoltaic
SCP	System Control Panel
STC	Standard Test Conditions specific to photovoltaic panels (1000 W/m ² , light spectrum AM 1.5 and 25°C); panel nameplate ratings are based on STC and may be exceeded under other conditions.
UL	Underwriters Laboratories
VAC	Volts AC
VDC	Volts DC
V_{MP}	Voltage at maximum power per STC
V_{OC}	Open circuit voltage rating of a PV panel under STC

Related Information

For more information about Schneider Electric as well as its products and services, visit solar.schneider-electric.com.

Important Safety Instructions

READ AND SAVE THESE INSTRUCTIONS - DO NOT DISCARD

This guide contains important safety instructions for the Conext MPPT Solar Charge Controller that must be followed during installation procedures. **Read and keep this Installation and Owner's Guide for future reference.**

Read these instructions carefully and look at the equipment to become familiar with the device before trying to install, operate, service or maintain it. The following special messages may appear throughout this bulletin or on the equipment to warn of potential hazards or to call attention to information that clarifies or simplifies a procedure.



The addition of either symbol to a "Danger" or "Warning" safety label indicates that an electrical hazard exists which will result in personal injury if the instructions are not followed.



This is the safety alert symbol. It is used to alert you to potential personal injury hazards. Obey all safety messages that follow this symbol to avoid possible injury or death.

DANGER

DANGER indicates an imminently hazardous situation which, if not avoided, will result in death or serious injury.

WARNING

WARNING indicates a potentially hazardous situation which, if not avoided, can result in death or serious injury.

CAUTION

CAUTION indicates a potentially hazardous condition which, if not avoided, can result in minor or moderate injury.

NOTICE

NOTICE indicates important information that indicates a potentially hazardous situation, which, if not avoided, can result in equipment damage.

Safety Information

1. **Before installing or using this device, read all instructions and cautionary markings located in (or on) this guide, the unit, the batteries, PV array, and any other equipment used.**
2. All electrical work must be done in accordance with local, national, and/or international electrical codes.
3. This product is designed for indoor mounting only. Do not expose this unit to rain, snow or liquids of any type.
4. To reduce the chance of short-circuits, use insulated tools when installing or working with the unit or any DC source (such as PV, hydro, wind, or batteries).
5. Remove all jewelry when installing or working with the unit or any DC source. This will greatly reduce the chance of accidental exposure to live circuits.
6. The unit contains more than one live circuit (batteries and PV array). Power may be present at more than one source.
7. This product contains no user-serviceable parts.

WARNING

LIMITATIONS ON USE

The Conext MPPT Solar Charge Controller is not intended for use in connection with life support systems or other medical equipment or devices.

DANGER

HAZARD OF ELECTRICAL SHOCK, EXPLOSION, OR ARC FLASH

- Apply appropriate personal protective equipment (PPE) and follow safe electrical work practices. See NFPA 70E or CSA Z462.
- This equipment must only be installed and serviced by qualified electrical personnel.
- Never operate energized with covers removed
- Energized from multiple sources. Before removing covers identify all sources, de-energize, lock-out, and tag-out and wait 2 minutes for circuits to discharge
- Always use a properly rated voltage sensing device to confirm all circuits are de-energized.
- Normally GROUNDED conductors may be UNGROUNDED and ENERGIZED when a GROUND FAULT is indicated on the front panel. Must be serviced by qualified personnel.

Failure to follow these instructions will result in death or serious injury.

⚠ CAUTION**BURN HAZARD**

Do not touch heatsink

Failure to follow these instructions can result in injury.

NOTICE**LIGHTNING PROTECTION**

To protect the solar charge controller's insulation and conductors from damage due to a sudden over-voltage surge such as a lightning strike, install a DC-rated lightning arrestor on the DC input line.

Failure to follow these instructions can damage the equipment.

Battery Safety Information

⚠ WARNING

A battery can produce the following hazards to personal safety:

- electrical shock
- burn from high-short-circuit current
- fire or explosion from vented gasses.

Observe proper precautions when working with or around batteries

- Always wear eye protection when working with batteries.
- Remove all jewelry before working with batteries.
- Wear rubber gloves and boots when handling batteries.
- Never work alone. Have someone assist you with the installation or be close enough to come to your aid when working with batteries.
- Always use proper lifting techniques when handling batteries.
- Always use identical types of batteries.
- Never install old or untested batteries. Check each battery's date code or label to ensure age and type.
- Batteries should be installed in a well-vented area to prevent the possible buildup of explosive gasses. If the batteries are installed inside an enclosure, vent its highest point to the outdoors.
- When installing batteries, allow at least 1 inch of air space between batteries to promote cooling and ventilation.
- NEVER smoke in the vicinity of a battery or generator.

- Always connect the batteries first, then connect the cables to the inverter or controller. This will greatly reduce the chance of spark in the vicinity of the batteries.
- Use insulated tools when working with batteries.
- When connecting batteries, always verify proper voltage and polarity.
- Do not short-circuit battery cables. Fire or explosion can occur.
- Do not open or damage the batteries. Exposure to electrolyte is harmful to eyes and skin. It is toxic.
- In the event of exposure to battery electrolyte, wash the area with soap and water. If acid enters the eyes, flood them with running cold water for at least 15 minutes and get immediate medical attention.
- Do not dispose of batteries in a fire.
- Always recycle old batteries. Contact your local recycling center for proper disposal information.
- Determine if the battery is inadvertently grounded and if so, remove the source from ground. Contact with any part of a grounded battery can result in electrical shock. Remove these grounds during installation and maintenance.

FCC Information to the User

This equipment has been tested and found to comply with the limits for a Class B digital device, pursuant to part 15 of the FCC Rules. These limits are designed to provide reasonable protection against harmful interference when the equipment is operated in a residential environment. This equipment generates, uses and can radiate radio frequency energy and, if not installed and used in accordance with the instruction guide, may cause harmful interference to radio communications. However, there is no guarantee that interference will not occur in a particular installation. If this equipment does cause harmful interference to radio or television reception, which can be determined by turning the equipment off and on, the user is encouraged to try to correct the interference by one or more of the following measures:

- Reorient or relocate the receiving antenna.
- Increase the separation between the equipment and the receiver.
- Connect the equipment to a different circuit from that to which the receiver is connected.
- Consult the dealer or an experienced radio/TV technician for help.

▲ CAUTION
Unauthorized changes or modifications to the equipment could void the user's authority to operate the equipment.

Contents

Important Safety Instructions - - - - -	v
Battery Safety Information - - - - -	1-vii
1 Introduction	
Features - - - - -	1-2
Maximum Power Point Tracking - - - - -	1-3
Charge Controlling - - - - -	1-4
Three-Stage Battery Charging - - - - -	1-5
Bulk Stage - - - - -	1-5
Absorption Stage - - - - -	1-5
Float Stage - - - - -	1-5
Two-Stage Battery Charging - - - - -	1-7
No Float Stage - - - - -	1-7
Battery Temperature Compensation - - - - -	1-9
Equalization Charging - - - - -	1-9
Auxiliary Output Functions - - - - -	1-10
Load Control - - - - -	1-10
Vent Fan - - - - -	1-10
Alarms - - - - -	1-10
Automatic PV Array Night Disconnect - - - - -	1-11
2 Installation	
Materials List and Tool Requirements - - - - -	2-2
PV Array Requirements - - - - -	2-2
MPPT Voltage Range - - - - -	2-2
Mounting - - - - -	2-3
Choosing a Location - - - - -	2-3
Removing the Wiring Compartment Cover - - - - -	2-6
Removing Knockouts - - - - -	2-6
Mounting the Charge Controller - - - - -	2-8
Grounding - - - - -	2-9
Internal Ground Fault Protection - - - - -	2-9
Disabling Ground Fault Protection for Negative Grounded and Ungrounded Arrays - - - - -	2-10
Installing a Positive-Grounded Battery System - - - - -	2-11
Disabling the Charge Controller's Internal PVGFP Circuit - - - - -	2-12
PV Connection and Auxiliary Lines - - - - -	2-13
Wiring - - - - -	2-14
DC Terminal Connector Locations - - - - -	2-14
Wire Size and Over-Current Protection Requirements - - - - -	2-14
Current Rating - - - - -	2-15

Minimum Wire Gauge - - - - -	2-15
Over-current Protection - - - - -	2-15
Long-distance Wire Runs - - - - -	2-15
Maximum One-way Distance and Wire Size - - - - -	2-16
Connecting the Charge Controller - - - - -	2-18
Connecting Multiple Units - - - - -	2-21
Aux Output Connections - - - - -	2-22
Disconnecting the Charge Controller - - - - -	2-24
Network Installation - - - - -	2-25
Network Components - - - - -	2-25
Network Layout - - - - -	2-26
Connecting Network Cable Between Multiple Units - - - - -	2-27
Installing the Battery Temperature Sensor - - - - -	2-28
Commissioning - - - - -	2-30
Conext Config Tool - - - - -	2-30
Configuration Screens - - - - -	2-30
Commissioning a Single Unit Without a System Control Panel - - - - -	2-31
Commissioning Multiple Units Without a System Control Panel - - - - -	2-32
Commissioning Units Using a System Control Panel - - - - -	2-34

3 Configuration

Configuring the Charge Controller - - - - -	3-2
Configuration Menus - - - - -	3-3
Basic and Advanced Menus - - - - -	3-3
Configuring Battery Characteristics and Battery Charging - - - - -	3-5
Setting a Custom Battery Type - - - - -	3-8
Battery Temperature Compensation - - - - -	3-10
Configuring Charge Controller Input - - - - -	3-11
Configuring the Auxiliary Output - - - - -	3-12
Trigger Source Descriptions - - - - -	3-14
Trigger Source Configurable Ranges - - - - -	3-15
Configuring the LCD - - - - -	3-16
Device Menu - - - - -	3-18
Resetting to Factory Defaults - - - - -	3-20

4 Operation

Viewing Operating Status - - - - -	4-2
LCD Screens and What They Mean - - - - -	4-2
Normal Operation - - - - -	4-3
Charge Stages - - - - -	4-6
Dynamic Text - - - - -	4-7
Monitoring Charge Controller Operation - - - - -	4-8
Viewing Active Faults and Warnings - - - - -	4-9
Viewing Logged System Data - - - - -	4-13

Daily Logs	4-14
Monthly Logs	4-14
Battery Equalization	4-14
5 Troubleshooting	
PV Charge Control Troubleshooting	5-2
Replacing the Ground Fault Protection Fuse	5-3
A Specifications	
Electrical Specifications	A-2
Default Battery Charging Settings	A-2
Mechanical Specifications	A-3
Output Power Versus Ambient Temperature	A-3
Optional Accessories	A-4
Regulatory Approvals	A-4
B Conext System Control Panel Menus	
Using the SCP	B-2
SCP Menu Map	B-3
Changing Settings Using the SCP	B-5
Viewing the Select Device Menu	B-5
Viewing the solar charge controller Setup Menu	B-5
Charge Controller Setup Menu	B-6
Configuration Settings	B-7
Monitoring the Charge Controller	B-10
Charge Controller Home Screen	B-10
Meters	B-11
C Boost Charging	
Using Boost Charging	C-2

1

Introduction

Chapter 1 describes features and functions of the Conext MPPT Solar Charge Controller.

It includes:

- Features
- Maximum Power Point Tracking
- Charge Controlling
- Auxiliary Output Functions
- Automatic PV Array Night Disconnect

Features

The Conext MPPT Solar Charge Controller (solar charge controller) is a photovoltaic (PV) charge controller that tracks the maximum power point of a PV array to deliver the maximum available current for charging batteries. The solar charge controller can be used with 12-, 24-, 36-, 48-, and 60-volt DC battery systems.

The solar charge controller is designed to regulate PV source, but will also work with other DC sources. To be used, the DC source must meet the specifications listed on page A-2.

The solar charge controller can be installed (in single or multi-unit configurations) with a Conext XW+ inverter/charger or as a stand-alone installation.

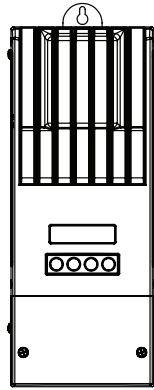

Figure 1-1 Conext MPPT Solar Charge Controller

Standard features of the solar charge controller include:

- Two- or three-stage charging process, with manual equalization to maximize system performance and maintain expected battery life.
- True dynamic Maximum Power Point Tracking (MPPT) to deliver the maximum available power from a PV array to a bank of batteries. See “Maximum Power Point Tracking” on page 1-3.
- Integrated PV Ground Fault Protection (PV-GFP).
- Convection cooled (no internal fan) using aluminum die-cast chassis and heat sink.
- 60-amp capacity.
- Configurable auxiliary output. See “Auxiliary Output Functions” on page 1-10.
- Two-line, 16-character liquid crystal display (LCD) with four buttons for configuration and system monitoring.
- Input over-voltage and under-voltage protection, output over-current protection, and backfeed (reverse current) protection. Warning and Fault messages appear on the LCD when the unit shuts down as a protective measure.

- Over-temperature protection and power derating when output power and ambient temperature are high.
- Battery Temperature Sensor (BTS) to provide automatically temperature-compensated battery charging. If the BTS is lost or damaged, a replacement can be ordered from Schneider (part number 808-0232-02).
- Xanbus communications network. Xanbus is a network communications system developed by the manufacturer which allows the solar charge controller to communicate settings and activity to other Xanbus-enabled devices.
- Five-year limited warranty.

Maximum Power Point Tracking

Maximum Power Point Tracking enables the solar charge controller to harvest the maximum energy available from the PV array and deliver it to the batteries.

The MPPT algorithm continuously adjusts the array operating voltage so that the array continuously operates at its maximum power point.

The solar charge controller applies a variable charging load on the array—shown by the power curve (solid line) in Figure 1-2—until it finds the maximum wattage (the point at which both operating voltage and current can be maximized at the same time), as indicated by “MPP” in Figure 1-2. The solar charge controller then holds the array at this point for as long as the array continues to produce the maximum power possible. As panel shading, cloud cover, and sunlight angle shift, the solar charge controller finds the new maximum power point without interrupting its output power flow.

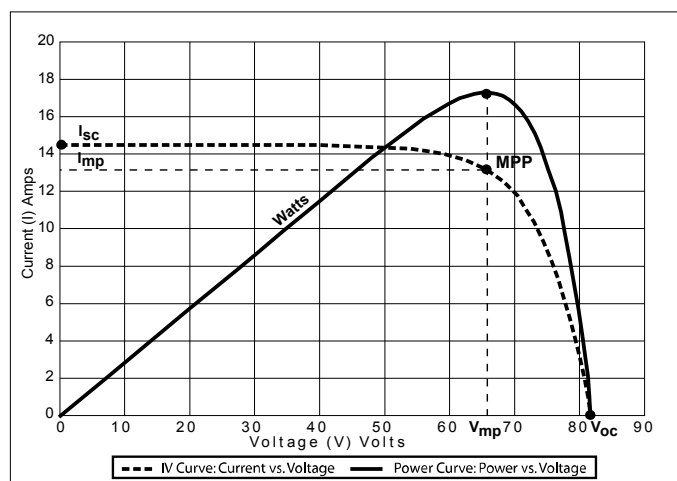

Figure 1-2 Maximum Power Point Curve

Charge Controlling

The solar charge controller can regulate PV array current for charging batteries at 12, 24, 36, 48, and 60 volts. It produces 60 amps of charging current and up to 3500 W (on 60-volt batteries) of charging power.

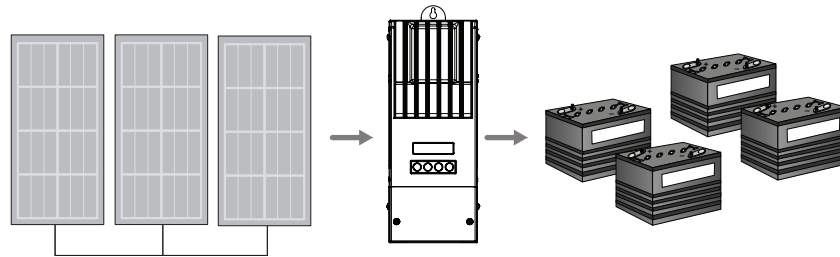

Figure 1-3 PV Charge Controller

The solar charge controller controls how the batteries are charged by the DC source (the PV array). It can be configured to use a two-stage (“No Float”) or three-stage charging process.

When charging, the solar charge controller regulates the charging voltage and current based on the amount of DC power available from the PV array and the current state of charge of the battery.

The solar charge controller is able to charge a lower nominal-voltage battery from a higher-nominal voltage array. For example, the solar charge controller can charge a 12-volt battery from a 36-volt array. This gives flexibility to installers to use longer wiring runs without compromising the efficiency of a higher-voltage array.

The solar charge controller is not able to charge a higher-voltage battery from a lower-voltage array.

Table 1-1 Battery to PV Array Voltages

Battery System Voltage	Minimum PV Array Voltage	Maximum PV Array Voltage (Operating)	Minimum PV Array Voltage (Open Circuit)
12V	15V	140V	150V
24V ^a	27V		
36V	39V		
48V ^a	54V		
60V	66V		

a. most common battery system voltage in PV and inverter systems

Three-Stage Battery Charging

The three-stage charging process results in more efficient charging compared to on-off relay type or constant voltage solid-state regulators. The final float stage reduces battery gassing, minimizes electrolyte loss, and ensures complete battery recharging. Battery voltage and current vary during the three-stage charging process as shown in Figure 1-4.

Bulk Stage

During the bulk stage, the solar charge controller operates in constant current mode, delivering maximum current to the batteries. When the battery voltage reaches the Absorption voltage setting, the controller automatically transitions to the absorption stage.

Absorption Stage

During the absorption stage, the solar charge controller operates in Constant Voltage mode and the current falls gradually as charge is returned to the battery. The voltage limit used for the first 60 minutes of this stage is the Bulk Voltage setting. The voltage limit used for the remaining time in this stage is the Absorption Voltage setting.

By default, the charge controller uses the same Bulk and Absorption voltage setting for all battery types. The default voltage limit settings (Bulk and Absorption) can be adjusted if the battery type is set to Custom. For flooded lead acid batteries only, a custom charging scheme can be used which sets the Bulk voltage higher than the Absorption voltage. The result of this is a boost voltage charge level, which has been found to be beneficial for ensuring effective charging of the battery bank for off-grid installations.

For detailed information on how Boost charging works and when it is recommended, please refer to Appendix C, "Boost Charging". The solar charge controller transitions to the float stage if either one of two conditions are met:

1. The charge current allowed by the batteries falls below the exit current threshold, which is equal to 2% of the programmed battery capacity (for a 500 amp-hour battery bank, this would be 10 amps), for one minute.
2. The solar charge controller has been in absorption for the programmed maximum absorption time limit. The default is 3 hours, but the time limit is programmable from 1 minute to 8 hours.

Float Stage

During the float stage, the voltage of the battery is held at the float voltage setting. Full current can be provided to the loads connected to the battery during the float stage from the PV array. When battery voltage drops below the ReCharge Volts setting for 1 minute, a new bulk cycle will be triggered.

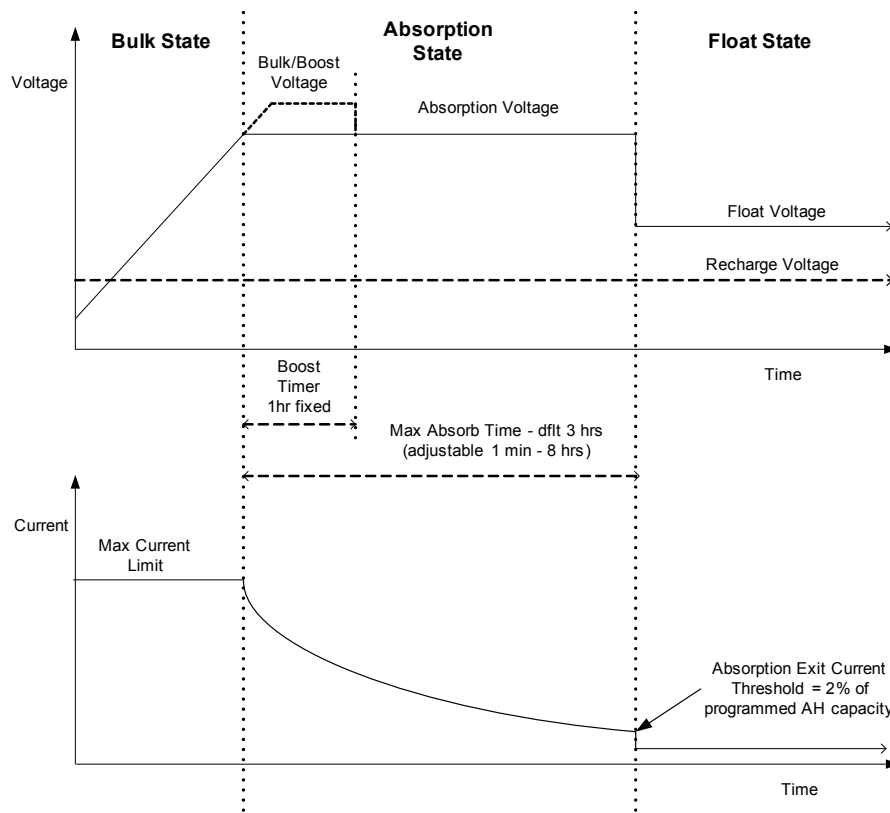

Figure 1-4 Three-stage Battery Charging Cycle^a

a. An actual charging cycle for a PV-based system that is in use while it is being charged will likely differ from the cycle represented in Figure 1-4. This is because a PV system's output is limited by the amount of solar energy available, and also because DC loads will affect the charge current and the measured battery voltage.

Note: This note is applicable to Figure 1-4 and Figure 1-5.

1. When the charge cycle is interrupted, the charger will restart charging at the beginning of the multi-stage algorithm.
 2. Exit Current Threshold can be effectively disabled by programming the amp hour capacity to zero. In this case, Absorption will only exit once the Max Absorption timer expires.
 3. Charge current during Equalize state (optional state not shown here) is normally limited to 10% of the programmed amp hour capacity setting. If this setting is programmed to zero Ah, the charge current during equalize is instead limited to whatever is programmed for the max current limit of the unit (default is 60A).
 4. Synchronized charge states are active when more than one charging device (MPPT or Inv/Chgr) is connected in the system via the Xanbus network.
 - i. The first unit to enter Bulk, causes all other chargers to enter Bulk.
 - ii. The first unit to enter Absorption, causes all other units to enter Absorption.
 - iii. The last unit that is ready to exit Absorption, triggers all units to exit Absorption and enter Float
-

Two-Stage Battery Charging

The two-stage charging process includes the bulk and absorption stages, but uses a “No Float” stage instead of “Float.” The relationship between charging current and battery voltage during the two-stage charging process is shown in Figure 1-5.

No Float Stage

During the No Float stage the solar charge controller does not produce any charge current. Instead the solar charge controller monitors the battery voltage and transitions back to the bulk stage once the voltage drops below the ReCharge Volts setting for one minute.

Note: For more information about battery charging settings, see Table 3-2 and Table 3-3.

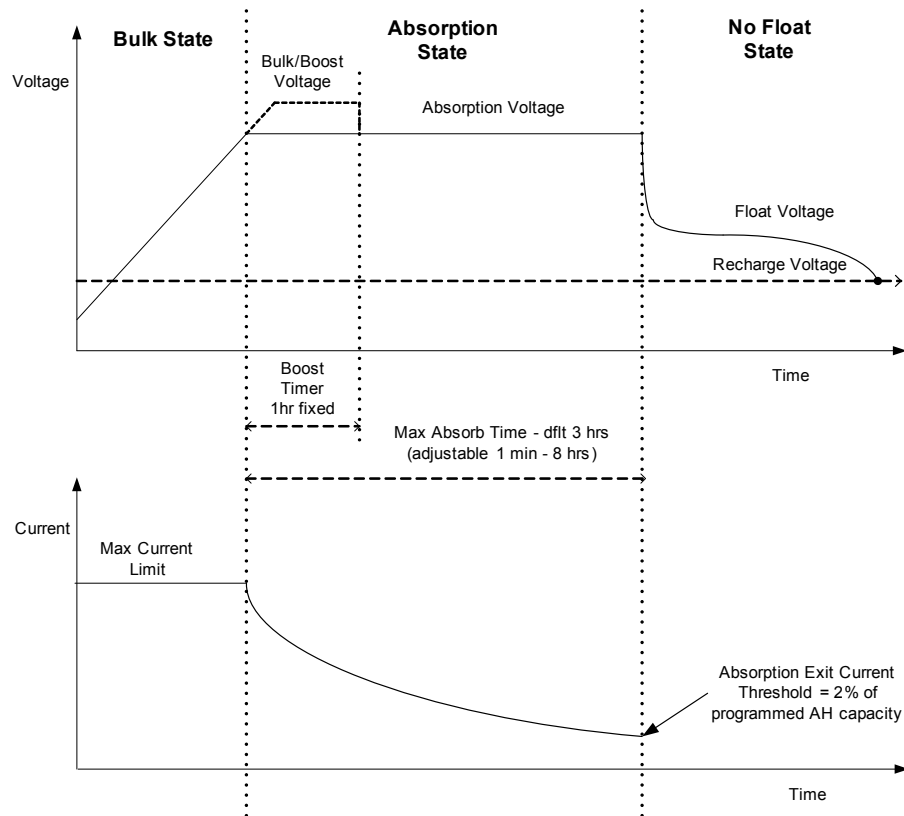

Figure 1-5 Two-stage Battery Charging Cycle

Battery Temperature Compensation

The Battery Temperature Sensor (BTS) automatically adjusts the charging process of the solar charge controller. With the BTS installed, the solar charge controller increases or decreases the battery charging voltage depending on the temperature of the battery to optimize the charge to the battery and to protect it from over-charge or damage. Using the BTS can extend battery life and improve overall charging.

The BTS plugs into the BTS jack located inside the wiring compartment of the solar charge controller. The BTS can be installed on the negative battery post or on the side of the battery.

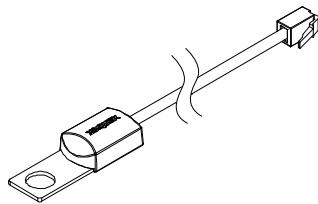

Figure 1-6 Battery Temperature Sensor

If the BTS is not installed, the voltage settings for charging are based on one of three temperature settings (Cold, Warm, or Hot) available on the solar charge controller configuration menu. See “Configuring Battery Characteristics and Battery Charging” on page 3–5.

If there are multiple charge controllers and Conext XW+ inverter/chargers connected to the Xanbus network, then one BTS is required per battery bank. All networked Xanbus devices share battery temperature information. If there is more than one BTS is used within the system, then the highest reported temperature will be used for the temperature compensation value of the battery charge algorithm.

Equalization Charging

The solar charge controller can be used to provide the battery bank with an equalize charge.

Equalization is a deliberate overcharge designed to return each cell in the battery to optimum condition by reducing sulfation and stratification in the battery. The equalization charge is generally performed only on flooded, vented (non-sealed or “wet”) lead-acid batteries, as recommended by the battery manufacturer.

To avoid damaging your batteries, be sure to read all cautions and warnings concerning equalization charging. For more information, see “Battery Equalization” on page 4–14.

Important: The solar charge controller maximum output voltage is limited to 72 volts for a 60-volt battery system, which is the bulk voltage setting for 60-volt batteries. Because of this output limit, the solar charge controller does not equalize 60-volt batteries.

Auxiliary Output Functions

The solar charge controller has a configurable auxiliary output (producing 5 to 13 volts at up to 200 milliamps) to drive a relay for load control or to turn on devices such as vent fans or indicator alarms. The auxiliary output can be configured to perform only one function at a time.

See “Configuring the Auxiliary Output” on page 3–12 for information about auxiliary output trigger sources and how to enable and configure the auxiliary output for your application.

▲ CAUTION

The auxiliary output is intended only to energize a low-current circuit such as a relay coil. Connection to a high-amperage device will open the fuse in the common line and possibly damage the unit.
--

Load Control

The solar charge controller auxiliary output can be configured to drive a relay to disconnect or reconnect loads depending on battery voltage. This load control function enables the solar charge controller to help prevent damage to the battery due to over-discharge during periods of poor charging (due to ambient temperature, for example) or excessive loads.

Vent Fan

The solar charge controller auxiliary output can be configured to power a small DC fan to clear a battery compartment of harmful gases. The solar charge controller auxiliary output must be configured to activate when the batteries reach their gassing voltage.

Alarms

The auxiliary output can be configured to trigger an alarm or indicator light when a pre-set condition occurs, such as low or high battery voltage, high PV array voltage, or a solar charge controller fault.

Automatic PV Array Night Disconnect

At night, or when the PV array voltage is less than the battery voltage, the solar charge controller opens an internal relay to prevent battery current from flowing back to the PV array. In this mode of operation the solar charge controller draws minimal power from the battery.

This automatic night-time disconnect eliminates the need for a blocking diode between the battery and the PV array. If the PV array consists of thin-film or amorphous solar modules, diodes may still be required to prevent damage during times of partial shading of the array. Check the documentation provided with the PV modules.

2

Installation

Chapter 2 contains information and procedures to install the Conext MPPT Solar Charge Controller.

It includes:

- Materials List and Tool Requirements
- PV Array Requirements
- Mounting
- Grounding
- Wiring
- Installing the Battery Temperature Sensor
- Commissioning

Before installing the solar charge controller, read this entire chapter. Depending on your installation, you may need to perform certain installation stages in a different order than the order presented in this chapter.

Materials List and Tool Requirements

The following materials are shipped with the charge controller:

- One Conext MPPT 60 150 Solar Charge Controller
- One *Conext Solar Charge Controller Owner's Manual*
- One CE Conformity Declaration
- One Battery Temperature Sensor (BTS)
- One network terminator

The following tools are required for installation:

- Phillips head screwdriver
- Wire cutters and wire strippers

PV Array Requirements

Note: The following information provides only general guidelines. The installation and rated performance of your PV array is subject to inspection and approval by the authority having jurisdiction.

Each Conext MPPT Solar Charge Controller (solar charge controller) must be connected to its own PV array. Although the solar charge controller can harvest a maximum of 3500 W, the PV array size can be as high as 6720 W (based on $48\text{ A} \times 140\text{ V}_{\text{oc}} = 6720\text{ W}$).

▲ CAUTION

The PV array voltage must never exceed 150 V_{oc} (open circuit voltage) under any conditions. The array I_{sc} (short circuit current) must not exceed the 60 A input current rating of the solar charge controller at any time.
--

Panels rated up to 48 A at 25°C (77°F) are recommended to allow for increases in I_{sc} caused by irradiance enhancement under certain conditions (reflection from snow, for example).

MPPT Voltage Range

The solar charge controller maximum power point tracking algorithm maximizes the energy drawn from a PV array as long as the array operating voltage is within the MPPT operational window. Charging begins when the input voltage is greater than the battery voltage. Ensure that the PV array used in the system operates within the MPPT operational window.

Effects of array voltages outside of the MPPT operational window are shown in Table 2-1.

Table 2-1 MPPT Operational Window

Voltage	Effect of Array Voltage	Charge Controller Mode
$V_{oc} < V_{batt}$ (system battery voltage)	Charge controller does not operate.	Low Light
$V_{MPP} < V_{batt}$	Harvest of solar energy less than optimal.	Charging
$V_{MPP} = V_{batt}$ to 120 VDC	Maximum harvest of solar energy.	Charging (MPPT window)
120 VDC $< V_{MPP} < 140$ VDC	Charge controller reduces the charging current to protect the unit from voltage spikes.	Input voltage derating
$V_{MPP} > 140$ VDC (or $V_{oc} > 140$ VDC)	Charge controller shuts down. Unit may be damaged if $V_{oc} > 150$ V.	Over-voltage fault

Mounting

The instructions in this chapter are applicable to a typical stand-alone installation. Installation procedures will vary according to your specific application. For special applications, consult a qualified electrician.

If installing the solar charge controller as part of an XW+ system, see the *Conext MPPT 60 150 Installation Guide* for more information.

Important: Installations must be compliant with all local electrical codes. Installation of this equipment should only be performed by a qualified electrician or by a Certified Renewable Energy (RE) System installer.

Choosing a Location

The solar charge controller must be mounted vertically and installed indoors in a dry, protected location away from flammable materials, sources of high temperature, moisture, and vibration. The location must also be sheltered from direct sunlight, rain, snow, and wind-blown debris.

▲ CAUTION

EQUIPMENT DAMAGE

Never install the solar charge controller where it is exposed to salt water spray. Exposure to salt water will void the warranty and may cause a shock hazard.

⚠ WARNING
EXPLOSION/CORROSION HAZARD
To reduce the risk of fire or explosion, do not install the solar charge controller in sealed compartments containing batteries or in locations that require ignition-protected equipment.
To reduce the risk of corrosion from hydrogen-sulfide gas vented by batteries, do not install the solar charge controller in sealed compartments containing batteries.

If using “sealed” batteries, the solar charge controller can be mounted in the same enclosure as long as it is adequately ventilated.

For optimal and safe operation, ensure there is adequate clearance around the solar charge controller. See Table 2-2 and Figure 2-1. If clearances are reduced below these minimums, rated performance may not be achieved.

Table 2-2 Minimum Clearance Requirements

Location	Minimum Clearance
Above	6 inches (150 mm). When units are mounted in a vertical stack, the topmost unit must maintain the minimum clearance to the nearest surface. Note: Minimum clearances can be ignored when mounting two units on the side of the Conext Power Distribution Panel (PDP). For more information, see the <i>Conext XW+ Inverter/Charger Installation Guide</i> . Other installations must follow the guidelines in this Guide.
In front	Sufficient room to allow for easy access to read the display, to prevent accidental contact with the heat sink, and to perform maintenance.
On sides	6 inches (150 mm) on at least one side of the overall assembly. A maximum of two units can be mounted side by side or side mounted against a PDP. In both configurations, the minimum clearance around the outermost unit must be maintained.

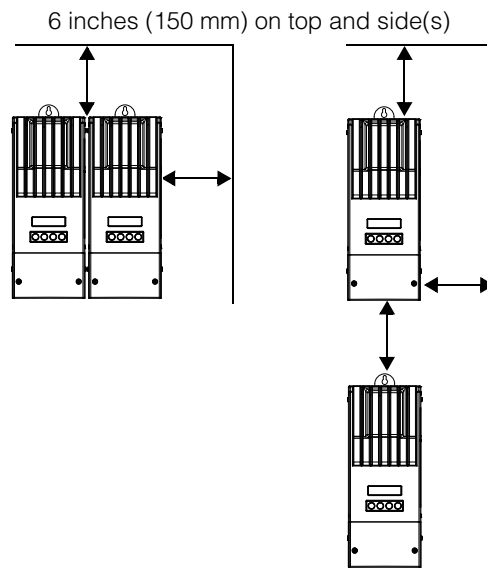

Figure 2-1 Minimum Clearance Requirements

Removing the Wiring Compartment Cover

Before mounting, remove the wiring compartment cover to access the mounting holes and the wiring terminals. The wiring compartment cover is secured with two Phillips #8-32 × 2 ½-inch (63.5 mm) screws on the front cover of the unit. See Figure 2-2.

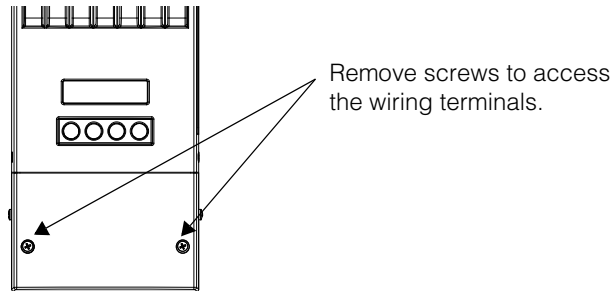

Figure 2-2 Removing the Wiring Compartment Cover

Removing Knockouts

Six dual and two single knockouts are provided for routing battery, PV array, BTS, and network cables into the solar charge controller. Use bushings or conduits to protect the wiring from damage from rough edges around the knockout holes.

When removing knockouts, ensure that no metal shavings or fragments fall into the wiring compartment.

Important: Do not drill, cut, or punch holes in the solar charge controller. Use only the knockouts provided for conduit entry.

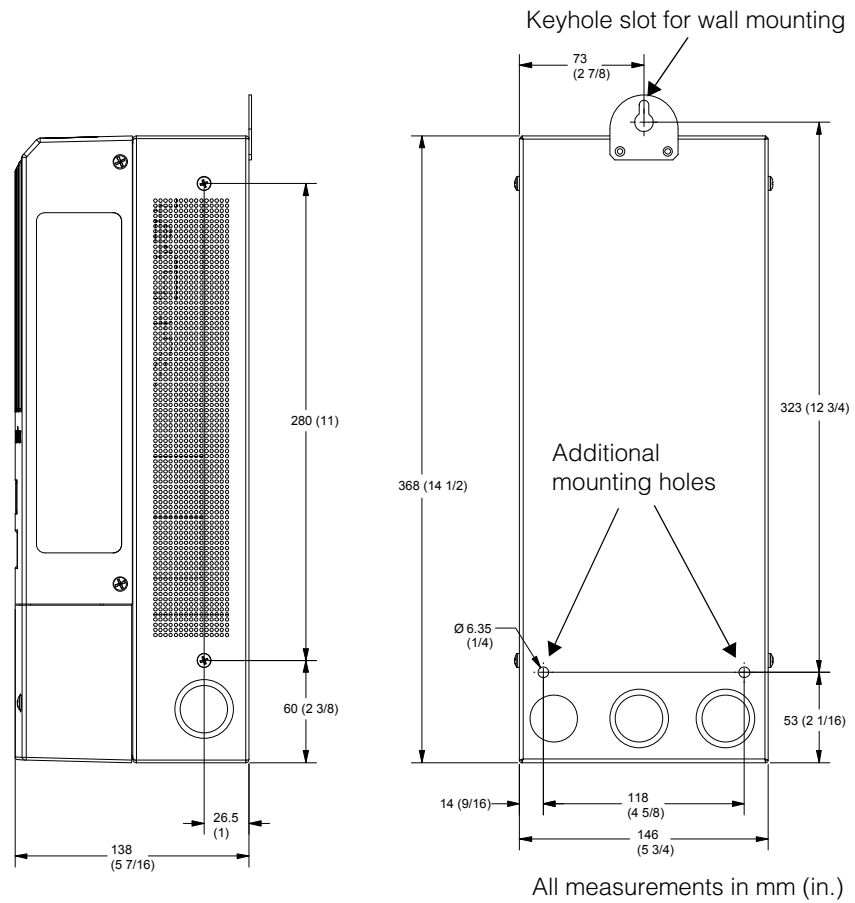

Figure 2-3 Dimensions and Knockout Locations

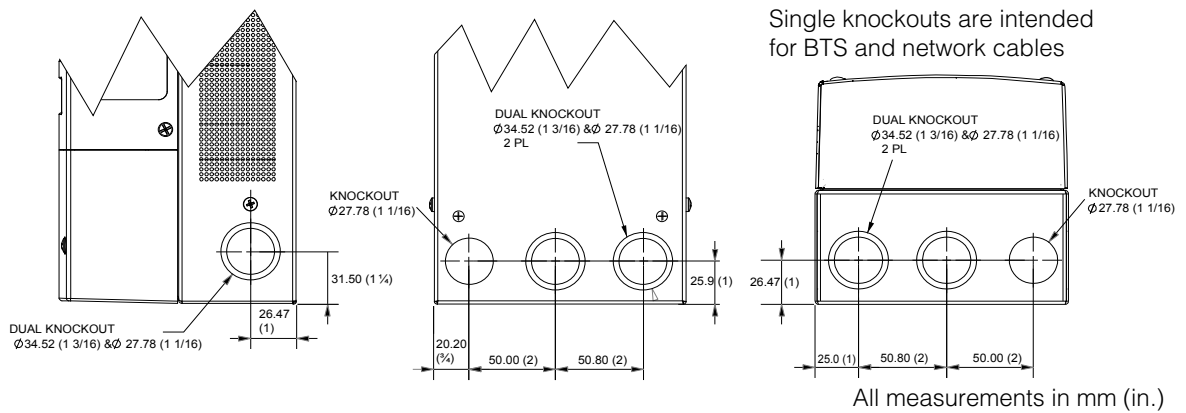

Figure 2-4 Knockout Dimensions

Mounting the Charge Controller

The solar charge controller is vertically mounted using three #10 × ½-inch or #12 × ½-inch (12.5 mm) pan-head screws.

To mount the solar charge controller:

1. Remove the wiring compartment cover.
2. Mark the location of the keyhole slot on the wall.
3. Secure the top mounting screw in the location marked. Leave the screw head backed out approximately ¼ inch (6 mm).
4. Place the controller onto the screw and pull it down into the keyhole slot.
5. Insert two screws in the two mounting holes provided to secure the unit to the wall.
6. Provide strain-relief clamps or conduit to prevent damage to the circuit board and terminal block from pulling on the wires.

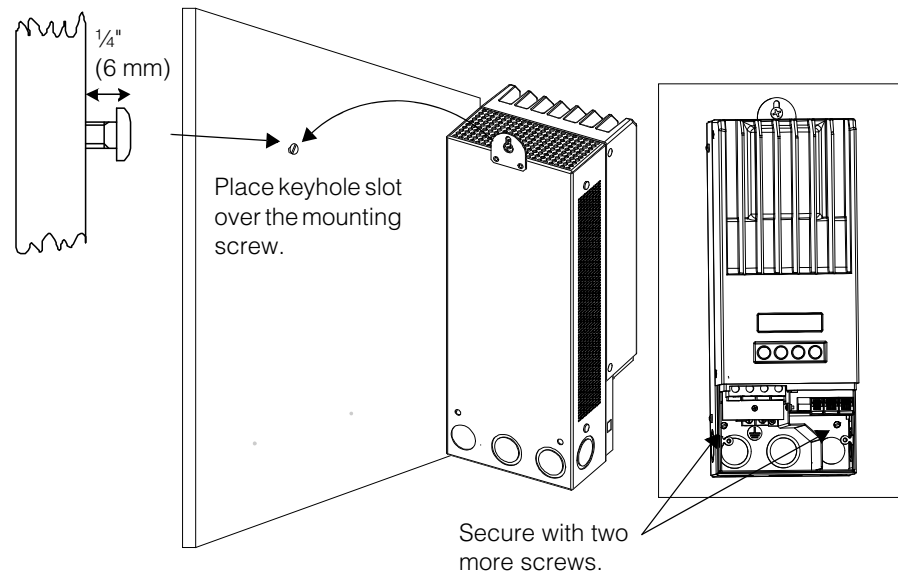

Figure 2-5 Mounting the Conext MPPT Solar Charge Controller

Grounding

The charge controller can be configured to be compatible with negative-grounded and ungrounded PV systems. For information about routing the ground connection, see Figure 2-10.

The maximum size of the ground conductor is #6 AWG (16 mm²). This wire gauge is determined by electrical code requirements regarding conduit knockout sizes, wire bending radius, and space available within the solar charge controller wiring compartment. For ground conductor requirements for your specific installation, consult your local electrical code.

Internal Ground Fault Protection

The solar charge controller has a PV ground fault protection (PV-GFP) fuse (600 V, 1 A) and a PV negative-ground jumper located inside the wiring compartment. These provide a negative ground bond and ground-fault protection for negative grounded PV array systems common in North American installations.

⚠ WARNING

ELECTRIC SHOCK HAZARD

If a ground fault is indicated, normally grounded conductors and battery terminals may be ungrounded and energized. Disconnect all sources of DC power and wait at least 4 minutes for the internal circuitry to discharge before servicing the unit. Failure to follow these instructions can result in death or serious injury.

⚠ WARNING

FIRE HAZARD

- Fuses must only be replaced by qualified service personnel, such as a certified electrician or technician. For continued protection against risk of fire, replace the fuse with Littelfuse KLKD 1 or equivalent..
- If PV-GFP is enabled, do not ground either PV negative or battery negative circuits. Grounding these circuits will defeat the internal PV-GFP protective function. See Figure 2-10 on page 2–20 for recommended battery circuit wiring.

Important: Only one Charge Controller is to have the PV-GFP fuse installed in installations with multiple parallel solar charge controllers. Before mounting and connecting the solar charge controllers, remove the PV-GFP fuse from each unit except one.

⚠ CAUTION

The factory default configuration of the solar charge controller will ground the PV array negative to the chassis ground through the internal PV-GFP fuse. The PV-GFP circuit must be disabled for ungrounded PV arrays.

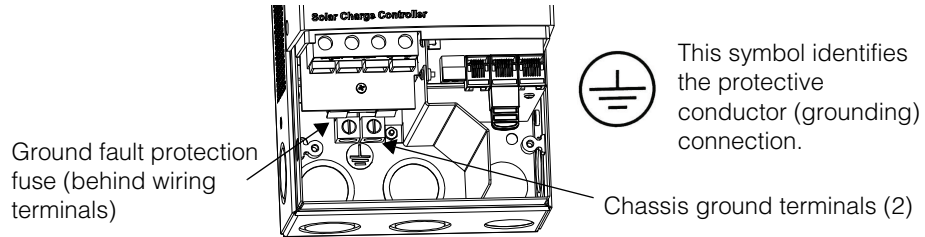

Figure 2-6 Charge Controller Safety Ground Connector

Disabling Ground Fault Protection for Negative Grounded and Ungrounded Arrays

To install the solar charge controller in a system where an external negative-ground bond is required or where the PV array must not be grounded, the solar charge controller internal PV-GFP circuit and ground bond must be disabled. To disable the unit's PV-GFP circuit and ground bond, move the jumper connector located on the circuit board within the wiring compartment. See Figure 2-7.

⚠ WARNING

SHOCK HAZARD

Disconnect PV and battery circuits before accessing the Charge Controller wiring compartment.

Disabling the PV-GFP circuit in this way opens the negative-to-ground bond within the unit. This provides the option of using an external PV-GFP circuit, operating the Charge Controller with an ungrounded PV array, or grounding the negative circuit of the battery elsewhere in the system.

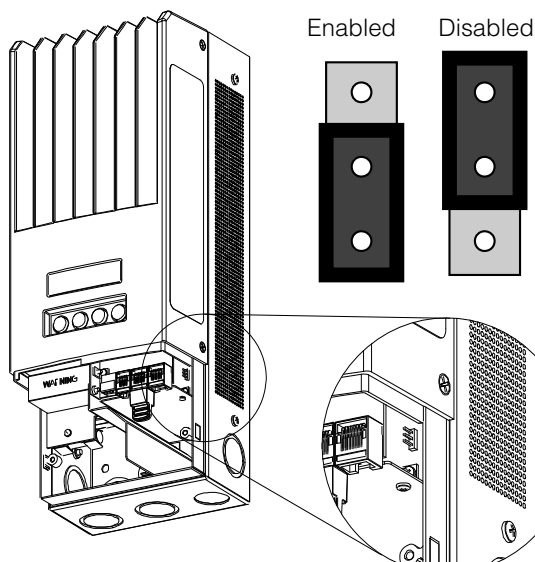

Figure 2-7 PV Negative Ground Jumper Location

Installing a Positive-Grounded Battery System

The solar charge controller's internal design has a built-in fuse—rated at 1 A, 600 V—which grounds both the PV negative and battery negative conductors and provides PV ground-fault protection (PVGFP) to the system.

To avoid a short circuit, ground fault protection must be disabled before grounding the positive battery terminal for negative voltage reference. Disabling the PVGFP circuit in this way opens the negative-to-ground bond within the unit, allowing for a positive battery ground connection.

If PVGFP is required, install an external protection circuit that is compatible with a positive-grounded battery system.

⚠ DANGER

HAZARD OF ELECTRIC SHOCK AND FIRE

PV array terminals and auxiliary terminals must not be grounded in the installed system.

Failure to follow these instructions will result in death or serious injury.

Because there is no isolation between the battery and the PV array, this positive-grounded battery configuration will bias the PV array terminals and the internal auxiliary lines to $-Batt\ V$ with respect to chassis ground.

For example, using a 150 VOC PV array and a 60 V battery bank, grounding the positive battery terminal will make PV(-) sit at -60 V and PV(+) at +90 V. Aux(-) will be biased at -60 V and Aux(+) at +45 V.

These voltage levels on both battery and auxiliary outputs are considered safe, extra-low voltages and do not present a hazard as long as the PV terminals are kept floated or ungrounded.

Follow the instructions in Chapter 2, "Installation" for connecting the PV array and battery to the unit. Next, follow these steps for a safe, negative voltage reference connection:

1. Disable the solar charge controller's internal PVGFP circuit. See "Disabling the Charge Controller's Internal PVGFP Circuit" on page 2-12.
2. Make sure PV array terminals (positive and negative) are ungrounded.
3. Make sure auxiliary terminal lines (positive and negative) are ungrounded.
4. Ground the positive terminal of the battery only.

Disabling the Charge Controller's Internal PVGFP Circuit

Before grounding the positive battery terminal to obtain a negative reference voltage, you must disable the solar charge controller's internal PVGFP circuit.

 DANGER
HAZARD OF ELECTRIC SHOCK
Disconnect PV and battery circuits before accessing the solar charge controller's wiring compartment.
Failure to follow these instructions will result in death or serious injury.

To disable the PVGFP circuit, remove the small jumper connector located on the circuit board within the wiring compartment of the unit. See Figure 2-8 for the jumper location. After removal, the jumper can be stored on a single pin of the 2 pin connector or moved into the location marked for units with a 3-pin connector.

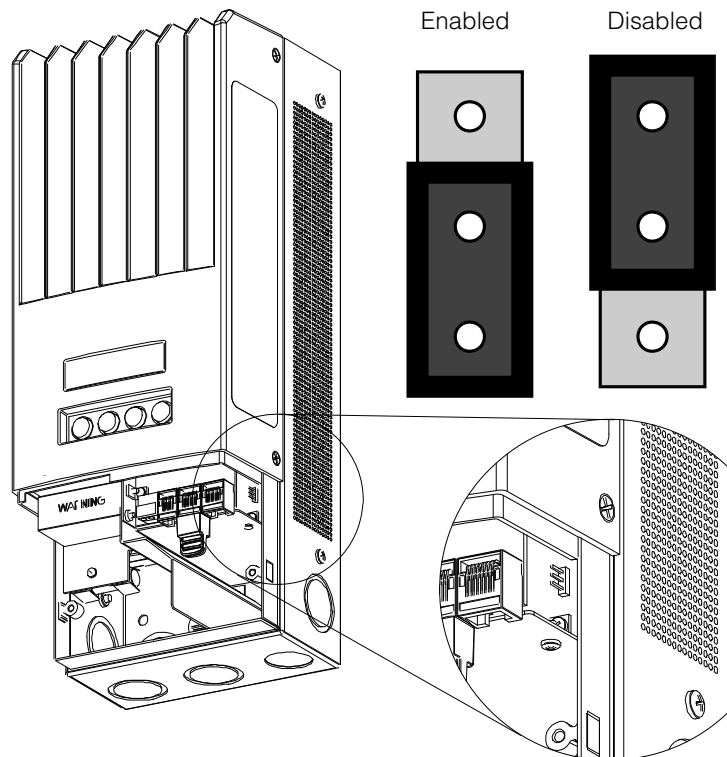

Figure 2-8 Jumper Location (CE Marked Model)

PV Connection and Auxiliary Lines

⚠ WARNING

HAZARD OF FIRE

Do not ground the negative conductor of the auxiliary circuit.

Failure to follow these instructions could result in death or serious injury.

The PV array must not be grounded in either its positive or negative terminal. Do not attempt to ground the PV+ terminal to have a common ground with the battery. A positive ground connection at the PV array will bias both battery and auxiliary terminals to -PV voltage with respect to chassis ground. This will present shock hazardous voltages at the battery terminals and the auxiliary lines.

The internal auxiliary connector lines must not be grounded in either their positive or negative terminal. Grounding the negative terminal of the auxiliary lines will create a short on the battery side outside the reach of the unit's over-current protection.

Wiring

Important: *Installations must meet all local electrical codes.* This equipment should only be installed by a qualified electrician or a Certified Renewable Energy System Installer.

⚠ WARNING
SHOCK HAZARD
Disconnect PV and battery circuits before wiring.

DC Terminal Connector Locations

Terminal connectors for DC wiring are located inside the wiring compartment. The labels above the DC wiring terminals and inside the wiring compartment identify all the connection points. See Figure 2-9.

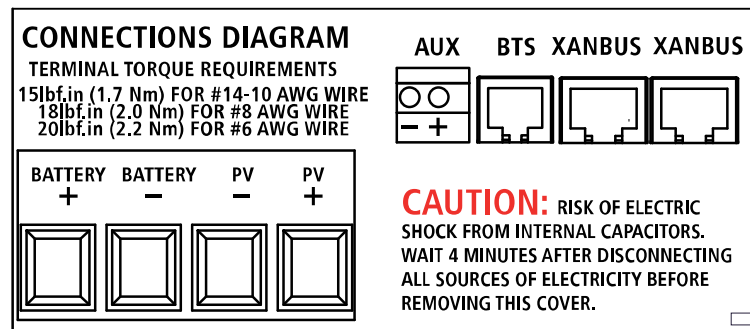

Figure 2-9 DC Connection Terminals

Wire Size and Over-Current Protection Requirements

The wiring, over-current protection devices (fuses and circuit breakers), and installation methods used must conform to all national and local electrical code requirements.

Wiring must be protected from physical damage with conduit or a strain relief clamp.

To preserve signal integrity on communication cables, the BTS, auxiliary output, and network cables must pass through a different conduit than the conduits used for PV and battery cables. You should pull the BTS cable through the conduit first as the connector may not fit if other wires have been pulled first.

Current Rating

The solar charge controller PV input is rated for 60 A maximum I_{SC} . Since PV outputs can vary due to the array size or sunlight angle, the safe minimum wire size must be chosen for maximum array short-circuit current. Consult PV array manufacturer specifications.

Minimum Wire Gauge

For installations where the PV array output is the maximum allowable 60 A I_{SC} , the minimum allowable wire gauge is #6 AWG (16 mm²) copper wire with a 90°C (194°F) insulation rating. This wire gauge is determined by electrical code requirements regarding conduit knockout sizes, wire bending radius, and space available within the solar charge controller wiring compartment.

No crimp-on terminals or lugs are required.

Over-current Protection

Over-current protection must be installed to protect the solar charge controller from short circuits and to provide a means of disconnecting the solar charge controller. Consult local electrical codes to establish the correct fuse or circuit breaker rating.

Battery Circuit

The NEC requires the battery circuit to be protected with a device rated for 125% of the rating of the circuit. The DC-rated fuse or circuit breaker between the battery and the solar charge controller must be rated for 1.25×60 A (the maximum current rating of the solar charge controller).

PV Circuit

A PV disconnect device between the PV array and the solar charge controller must be rated for 60 A.

Long-distance Wire Runs

If there is a significant distance between the PV array and the solar charge controller or between the solar charge controller and the battery, larger gauge wires can be used to reduce the voltage drop and improve performance. Refer to Table 2-3.

⚠ WARNING
<p>EQUIPMENT DAMAGE</p> <p>Do not connect an array capable of delivering over 60 A I_{SC} to the solar charge controller. Wire sizes larger than #6 AWG (16 mm²) may be used to reduce resistive losses but should not be installed directly into the solar charge controller. Use a splicer block or similar to connect wires of different gauges together. Follow manufacturer's recommendations for torque and mounting.</p>

Maximum One-way Distance and Wire Size

Important: Local and national electrical codes must be followed for determining additional installation requirements.

Refer to Table 2-3 and find the maximum current in the left column, and the one-way distance from the PV array to the solar charge controller (or the distance from the solar charge controller to the battery) on the same line, then read the wire size required at the top of the column.

For equivalent metric wire sizes, consult a local electrician or certified installer.

Table 2-3 One-Way Wire Distance and Wire Size

Maximum one-way wire distance for a < 3% voltage drop assuming 60 A charging current

12 Vdc application shown

For 24 Vdc systems, multiply distance by 2

For 36 Vdc systems, multiply distance by 3

For 48 Vdc systems, multiply distance by 4

For 60 Vdc systems, multiply distance by 5

Amps	Distance in feet (meters)				Distance in feet (meters) ^a				
	12 AWG	10 AWG	8 AWG	6 AWG	4 AWG	3 AWG	2 AWG	1 AWG	1/0 AWG
10	8.8 (2.68)	14 (4.27)	22.2 (6.77)	35.3 (10.76)	56.1 (17.10)	70.9 (21.61)	89.6 (27.31)	112.5 (34.29)	141.7 (43.19)
12	7.3 (2.23)	11.6 (3.54)	18.5 (5.64)	29.4 (8.96)	46.7 (14.23)	59.1 (18.01)	74.6 (22.74)	93.7 (28.56)	118.1 (36.00)
14	6.3 (1.92)	10 (3.05)	15.9 (4.85)	25.2 (7.68)	40.1 (12.22)	50.6 (15.42)	64.0 (19.51)	80.4 (24.51)	101.2 (30.85)
16	5.5 (1.68)	8.7 (2.65)	13.9 (4.24)	22.1 (6.74)	35.0 (10.67)	44.3 (13.50)	56.0 (17.07)	70.3 (21.43)	88.6 (27.01)
18	4.9 (1.49)	8.8 (2.38)	12.4 (3.78)	19.6 (5.97)	31.2 (9.51)	39.4 (12.01)	49.8 (15.18)	62.5 (19.05)	78.7 (23.99)
20	4.4 (1.34)	7 (2.13)	11.1 (3.38)	17.6 (5.36)	28.0 (8.53)	35.4 (10.79)	44.8 (13.66)	56.2 (17.13)	70.9 (21.6)
25		5.6 (1.71)	8.9 (2.71)	14.1 (4.30)	22.4 (6.83)	28.3 (8.63)	35.8 (10.91)	45.0 (13.72)	56.7 (17.28)
30		4.7 (1.43)	7.4 (2.26)	11.8 (3.60)	18.7 (5.70)	23.6 (7.19)	29.9 (9.11)	37.5 (11.43)	47.2 (14.39)
35			6.4 (1.95)	10.1 (3.08)	16.0 (4.88)	20.2 (6.16)	25.6 (7.80)	32.1 (9.78)	40.5 (12.34)
40			5.6 (1.71)	8.8 (2.68)	14.0 (4.27)	17.7 (5.39)	22.4 (6.83)	28.1 (8.56)	35.4 (10.79)
45				7.8 (2.38)	12.5 (3.81)	15.7 (4.79)	19.9 (6.07)	25.0 (7.62)	31.5 (9.60)
50				7.1 (2.16)	11.2 (3.41)	14.2 (4.33)	17.9 (5.46)	22.5 (6.86)	28.3 (8.63)

Table 2-3 One-Way Wire Distance and Wire Size

Maximum one-way wire distance for a < 3% voltage drop assuming 60 A charging current

12 Vdc application shown

For 24 Vdc systems, multiply distance by 2

For 36 Vdc systems, multiply distance by 3

For 48 Vdc systems, multiply distance by 4

For 60 Vdc systems, multiply distance by 5

Amps	Distance in feet (meters)				Distance in feet (meters) ^a				
	12 AWG	10 AWG	8 AWG	6 AWG	4 AWG	3 AWG	2 AWG	1 AWG	1/0 AWG
60				6.3 (1.92)	9.3 (2.83)	11.8 (3.60)	14.9 (4.54)	18.7 (5.7)	23.6 (7.19)

a. These wire sizes are not approved to be installed in the controller, but may be used external to the controller (using a splicer block) to reduce voltage drop and improve performance.

Connecting the Charge Controller

The following procedure is illustrated in Figure 2-10.

⚠ WARNING
HAZARD OF ELECTRIC SHOCK
The PV array will produce a hazardous voltage with even a small amount of light. Appropriate measures must be taken to prevent electric shock.

⚠ WARNING
SHOCK HAZARD
Do not connect the battery negative to ground. Bonding the battery negative to ground disables the unit's internal PV ground-fault protection. For more information, see "Grounding" on page 2-9. See Figure 2-10 for correct routing of the battery negative.

⚠ CAUTION
EQUIPMENT DAMAGE
Do not connect the PV negative and battery negative terminals together anywhere in the system, including the XW Power Distribution Panel or other DC disconnect. The PV negative and battery negative must be connected to separate terminals as marked on the unit.

To connect the solar charge controller:

1. Ensure the PV array disconnect and battery disconnect are turned off.
2. Ground the solar charge controller. Connect a grounding conductor between an solar charge controller ground lug and the system ground (as shown in Figure 2-10).
3. Connect the PV array negative (-) output to the solar charge controller terminal marked PV -.
4. Connect the PV array's positive (+) output to the PV array disconnect.
5. Route another positive (+) cable from the other end of the PV disconnect to the solar charge controller terminal marked PV +.
6. Connect the negative (-) battery cable to the solar charge controller terminal marked BAT -.
7. Connect a positive (+) cable from the solar charge controller terminal marked BAT + to the battery disconnect.

⚠ CAUTION**REVERSE POLARITY DAMAGE**

Before making the final DC connection or closing the DC breaker or disconnect, check cable polarity at both the battery and the solar charge controller. Positive (+) must be connected to positive (+). Negative (-) must be connected to negative (-).

8. Connect a second positive (+) cable to the other side of the battery disconnect and connect to the positive (+) battery terminal.
9. Torque the solar charge controller terminals according to the following table:

Wire Size		Torque Value	
AWG	mm ²	in-lb	Nm
14-10	2.5-6	15	1.7
8	10	18	2
6	16	20	2.25

Allow some slack on the cables within the solar charge controller and secure the wiring with strain reliefs or cable clamps.

NOTICE**LIGHTNING PROTECTION**

To protect the solar charge controller's insulation and conductors from damage due to a sudden over-voltage surge such as a lightning strike, install a DC-rated lightning arrester on the DC input line.

Failure to follow these instructions can damage the equipment.

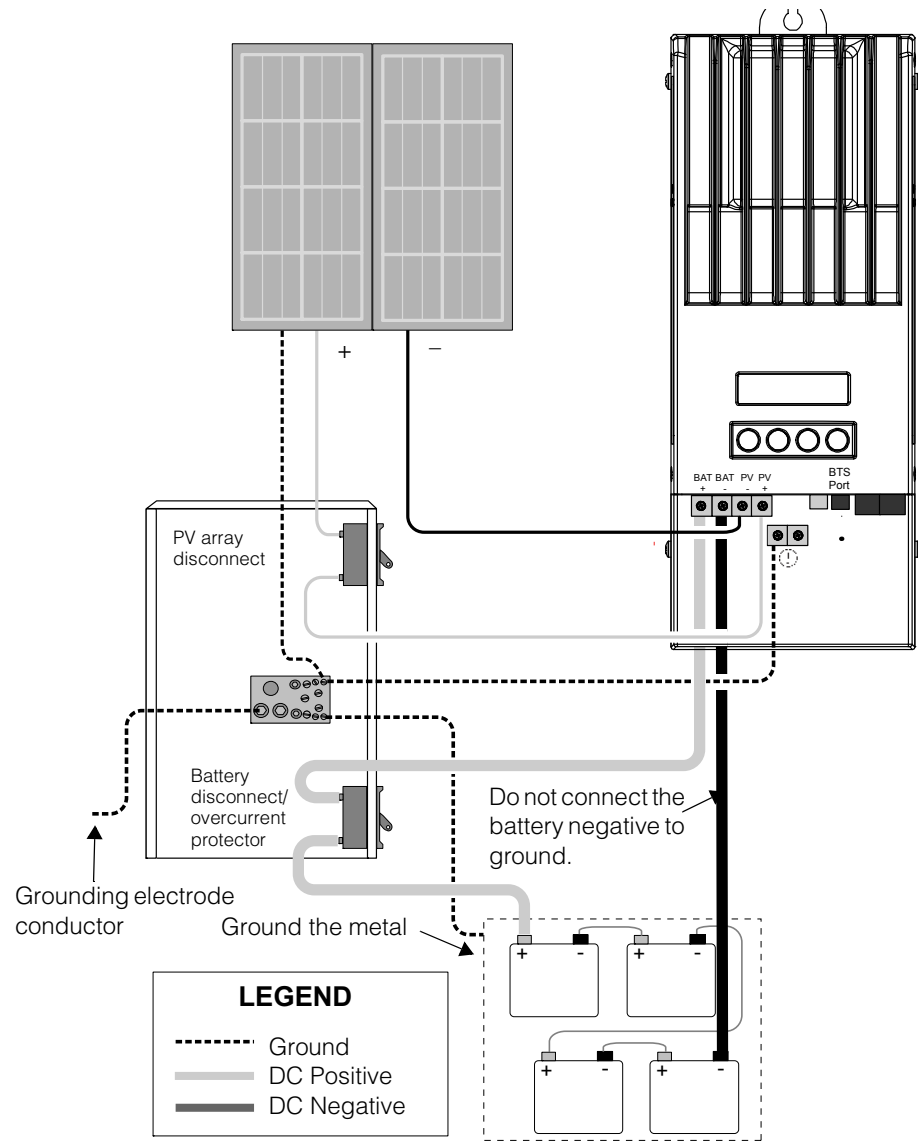

Figure 2-10 Charge Controller Power Wiring

Connecting Multiple Units

In a multiple-unit installation, each solar charge controller must be connected to a separate PV array. For other multiple-unit installation considerations, see “Network Installation” on page 2–25.

Important: Only one solar charge controller is to have the PV-GFP fuse installed in installations with multiple parallel solar charge controllers. Before mounting and connecting the solar charge controllers, remove the PV-GFP fuse from each unit except one.

⚠ WARNING

SHOCK HAZARD AND EQUIPMENT FAILURE

Ensure each solar charge controller is correctly connected to its own PV array(s) and that no wires are crossed. See Figure 2-11. For example, if PV1 positive and PV2 negative are connected to solar charge controller #1 and PV2 positive and PV1 negative are connected to solar charge controller #2, current will flow through the solar charge controllers' chassis and cause the ground fault protection fuse to blow, followed by short circuit failure.

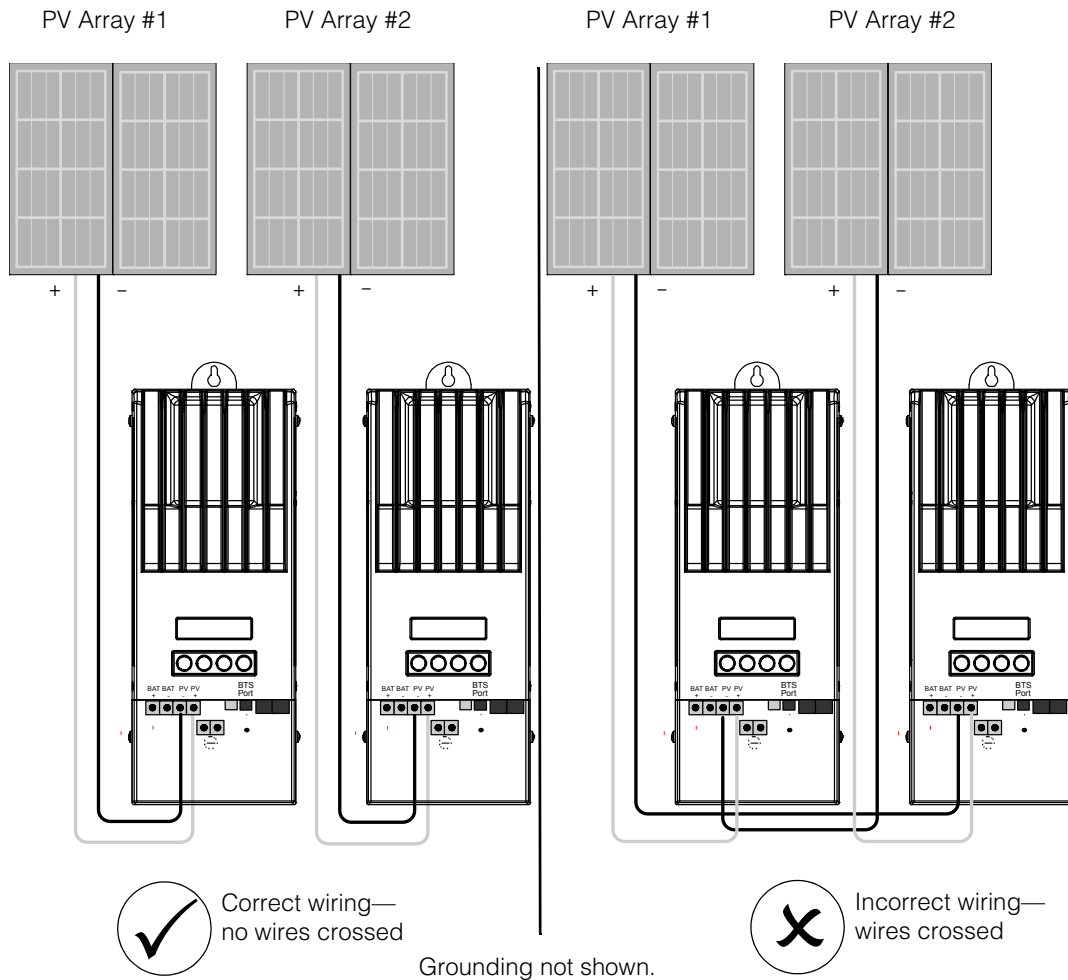

Figure 2-11 Multiple Charge Controller Array Wiring

Aux Output Connections

⚠ WARNING

SHOCK HAZARD

If the PV-GFP internal protection has activated, shock-hazardous voltage may appear at the AUX connector and at the battery terminals. To avoid a shock hazard, ensure that all connections made to the AUX terminals have no uninsulated wire segments and that all wiring has an insulation rating of at least 300 V.

⚠ CAUTION

The auxiliary output is intended only to energize a low-current circuit such as a relay coil. Connection to a high-amperage device will open the fuse in the common line and possibly damage the unit.

The auxiliary output connectors can accept #22 to #14 AWG (0.5 to 1.5 mm²) copper solid or stranded wire. The auxiliary output is short-circuit protected and is disabled when a ground fault occurs.

To use the solar charge controller to control loads and protect your batteries, you must connect the solar charge controller auxiliary output to a relay that controls a battery disconnect to disconnect the load from the batteries. As shown in Figure 2-12, the auxiliary output can also power a fan to vent the battery compartment. The solar charge controller auxiliary output (producing 5 to 13 V and up to 200 mA) must be configured to activate when the batteries reach a pre-set voltage level. See “Configuring the Auxiliary Output” on page 3–12.

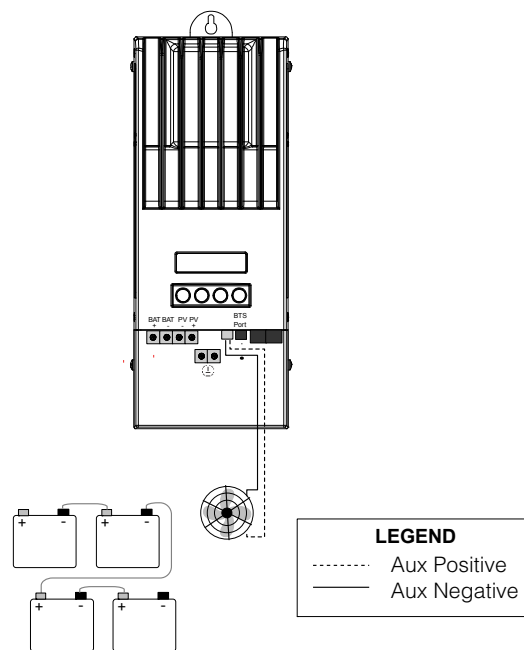

Figure 2-12 Auxiliary Output Vent Fan Application

Disconnecting the Charge Controller

⚠ WARNING

SHOCK HAZARD

Ensure both the PV array and the batteries are disconnected from the solar charge controller before servicing the solar charge controller or the batteries. After disconnecting the batteries, the solar charge controller can appear de-energized when the PV array is still connected.

⚠ WARNING

SHOCK HAZARD

After disconnecting power from the solar charge controller, wait at least four minutes before attempting any maintenance or cleaning or working on any circuits connected to the unit. Internal capacitors remain charged for four minutes after disconnecting all sources of power.

Before disconnecting batteries and the PV array from the unit, ensure the solar charge controller is not charging the batteries. If the solar charge controller is charging, you can wait until the charge cycle is complete or the solar charge controller displays “Low Light,” or you can put the unit into standby mode. Standby mode shuts off the solar charge controller output. The solar charge controller can be put into standby mode using the solar charge controller Device Menu or the MPPT Setup Menu on the Conext System Control Panel (SCP).

If the solar charge controller is charging when the batteries are disconnected with a DC disconnect switch, an over-voltage output fault occurs due to the load on the solar charge controller output being removed. After approximately 10 seconds the solar charge controller LCD goes blank and the solar charge controller loses power.

Normal operation resumes when the battery is reconnected.

If the unit is not charging, the charge controller simply shuts down when the batteries are disconnected. No faults are generated.

Network Installation

The Conext Solar Charge Controller is a Xanbus-enabled device. Xanbus is a network communications protocol developed by Schneider Electric. The solar charge controller is able to communicate its settings and activity to other Xanbus-enabled devices, such as the Conext XW+ inverter/charger, Conext System Control Panel (SCP), Conext Automatic Generator Start (AGS), and other charger controllers.

Xanbus connections between multiple solar charge controllers allows information about each solar charge controller and its associated PV array to be communicated between all of the solar charge controllers in the system. Information about the entire system can be displayed on any solar charge controller LCD in the system.

For example, in a two-solar charge controller system, if solar charge controller #1 is producing 1500 W and solar charge controller #2 is producing 2000 W, both units display a total system power of 3500 W. The accumulated amp-hours and kilowatt-hours produced by both units that day is also displayed.

Networked solar charge controllers also share battery temperature information if a single BTS is connected to a single solar charge controller or Conext XW+ inverter/charger) in the system.

Without Xanbus connections, each solar charge controller in a system will only display information specific to the unit and its associated PV array.

Network Components

A Xanbus network consists of the following components:

- Xanbus-enabled devices:
 - Conext Solar Charge Controller
 - Conext XW+ inverter/charger
 - Conext Automatic Generator Start
 - Conext System Control Panel or Conext ComBox
- Xanbus power supply—When only solar charge controllers are installed, a Xanbus power supply is required to supply network power. The charge controller does not provide Xanbus power. The solar charge controller will communicate with other solar charge controllers, but the units can not supply network power to any other devices.

In systems that combine solar charge controllers with other Xanbus-enabled devices, the Conext XW+ provides the required 15 Vdc/200 mA network power.

- Network cables—Each Xanbus-enabled device is connected by a standard Ethernet (CAT 5 or CAT 5e) cable, available from any computer supply store.

⚠ CAUTION

EQUIPMENT DAMAGE

Do not use crossover cable.

- Network terminators (Figure 2-13)—the Xanbus network must be properly terminated at each end to ensure the communication signal quality on the network. Network terminators plug into network ports on Xanbus-enabled devices. The solar charge controller and other Xanbus-enabled devices ship with one terminator. Depending on your network layout, this terminator may need to be inserted into another device elsewhere in the network.

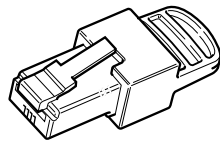

Figure 2-13 Network Terminator

Network Layout

Xanbus-enabled devices are connected with separate lengths of cable. The devices at each end of the chain must have a terminator inserted into their open network ports, as shown in Figure 2-14.

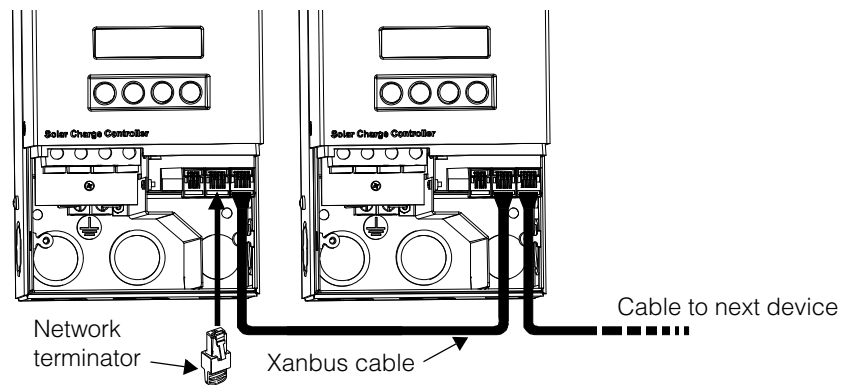

Figure 2-14 Network Layout

Connecting Network Cable Between Multiple Units

⚠ WARNING

SHOCK HAZARD

Do not route the network cables in the same conduit or panel as the DC input/output cables.

⚠ WARNING

SHOCK HAZARD

Before opening the solar charge controller wiring compartment, ensure the PV array and batteries are disconnected. To reduce the risk of shock, cover the array with an opaque (dark) material.

Single knockouts on the back and bottom of the solar charge controller are provided for routing the Xanbus network cables. See Figure 2-4. See Figure 2-9 for the location of the solar charge controller Xanbus ports.

⚠ CAUTION

EQUIPMENT DAMAGE

Connect only Xanbus-enabled devices.

Although the cabling and connectors used in this network system are the same as ethernet connectors, this network is not an ethernet system. Equipment damage may result from attempting to connect the solar charge controller to different systems.

⚠ CAUTION

UNPREDICTABLE DEVICE BEHAVIOUR

Do not connect one end of the network to the other to make a ring or loop.

To connect network cables between multiple units:

1. Remove the wiring compartment cover from each unit.
2. Remove a single knockout from the back or bottom of each solar charge controller.
3. Connect the network cable to a Xanbus port in solar charge controller #1.
4. Route the cable to solar charge controller #2.
5. Connect the network cable to a Xanbus port in solar charge controller #2.

6. Connect another network cable to solar charge controller #2 and route the cable to the next device in the network.
7. Ensure the factory-supplied network terminators are inserted into the empty Xanbus ports in the devices at the beginning and end of the network. There should be no empty Xanbus ports in any of the solar charge controllers.

Installing the Battery Temperature Sensor

Installing a Battery Temperature Sensor (BTS) is recommended for optimum charging performance and extending battery life.

If a BTS is not installed and the batteries will operate in hot or cold conditions, manually adjust the temperature settings to suit the conditions. See “Configuring Battery Characteristics and Battery Charging” on page 3-5.

If there are multiple charge controllers and Conext XW+ inverter/chargers connected to the Xanbus network, then only one BTS is required per battery bank. All networked Xanbus devices share battery temperature information. If there is more than one BTS is used within the system, then the highest reported temperature will be used for the temperature compensation value of the battery charge algorithm.

See Figure 2-9 for the location of the solar charge controller BTS port. Single knockouts on the back and bottom of the solar charge controller are provided for routing the BTS cable. See Figure 2-4.

Important: If the sensor cable is damaged and the wires are shorted, the solar charge controller displays an over-temperature fault message. If the BTS wires have been cut, the solar charge controller assumes that the BTS is not connected.

Replacement Battery Temperature Sensors are available from Schneider (replacement part number 808-0232-02).

To install the BTS:

1. Remove the solar charge controller’s wiring compartment cover.
2. If necessary, remove a single knockout from the back or bottom of the solar charge controller.
3. Connect the ring terminal on the BTS directly to the negative battery terminal (recommended), or use the adhesive backing on the sensor back to attach the sensor to any side of the battery to be monitored. See Figure 2-15.

If using the adhesive backing, install the BTS on the side of the battery below the electrolyte level. It is best to place the sensor between batteries and place the batteries in an insulated box to reduce the influence of the ambient temperature outside the battery enclosure.

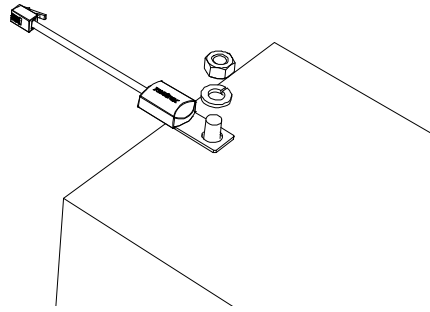

Figure 2-15 Attaching the BTS to a Battery Terminal

4. Pass the end of the BTS cable through a conduit hole on the solar charge controller and insert the BTS plug into the BTS port. See Figure 2-16.

Important: The BTS cable must not pass through the same conduit used for PV wiring and battery cables.

5. Replace the solar charge controller wiring compartment cover.

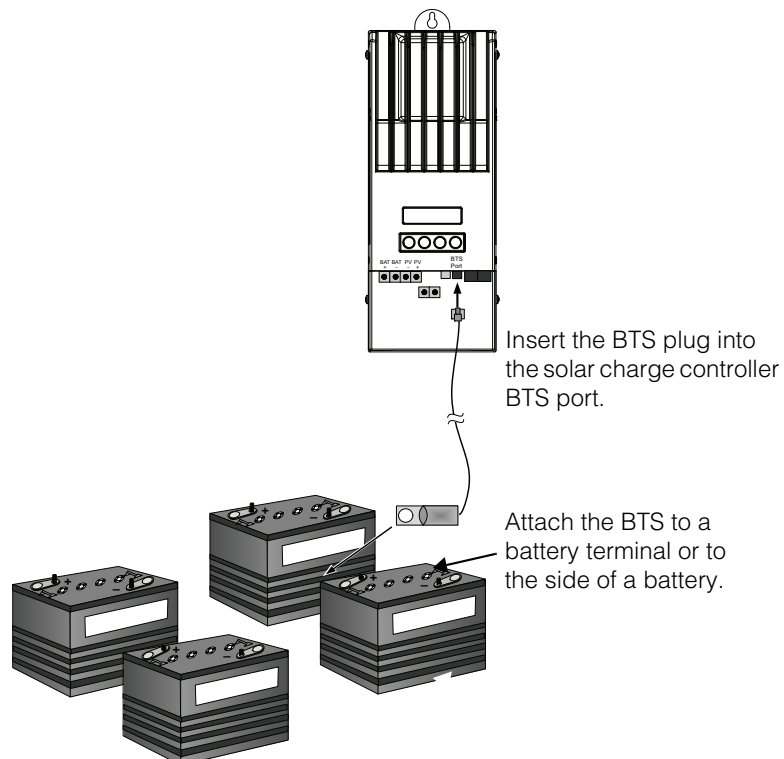

Figure 2-16 Installing the BTS

Commissioning

During commissioning, the solar charge controller prompts you to enter important system information such as the nominal battery voltage, battery type, and battery bank capacity. Ensure you have this system information prior to commissioning.

In systems where a SCP is present, the SCP is intended to be the configuration interface, so the prompt screens on the charge controller are suppressed. See “Commissioning Units Using a System Control Panel” on page 2–34. If you prefer to configure using the prompt screens, disconnect the Xanbus cable from the solar charge controller before powering up for the first time.

In place of the SCP, the Conext ComBox (ComBox) (Part Number 865-1055) can also be used. The ComBox allows you to configure and monitor the charge controller through a web interface on a PC or laptop. See the *Conext ComBox Owner's Guide* (Document Part Number 975-0679-01-01)

NOTICE
You must use the SCP with firmware version 1.05.00 or higher for full compatibility with the solar charge controller. For information on updating your firmware, contact customer service. To upgrade, use the ComBox or Context Config Tool.

Conext Config Tool

The Conext Config Tool (Part Number 865-1155) is a commissioning tool used for configuring or upgrading a Conext system. The Config Tool is available to installers only by request. Contact customer service for more information.

Configuration Screens

When power is first applied to the solar charge controller, several configuration screens prompt you to enter the following information:

- A “DC out” (battery) connection, which enables the solar charge controller to read and share the same battery information with other Xanbus-enabled devices that charge or invert from the same battery bank.
- Battery type: Flooded (default), Gel, AGM, Custom.
If you select Custom, the settings for battery type match the default settings for Flooded batteries until you reconfigure the settings on the Custom Battery menu. See “Setting a Custom Battery Type” on page 3–8.
- Nominal battery voltage of the battery bank connected to the solar charge controller.
Enter the correct system voltage on this screen.
- Battery bank capacity, in amp-hours.

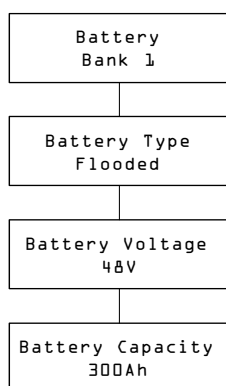

Figure 2-17 Configuration Screens

Commissioning a Single Unit Without a System Control Panel

To commission the solar charge controller:

1. Apply battery power to the unit.

The LCD displays the two startup screens in sequence, as shown in Table 2-4, followed by the first of four configuration prompt screens. The four configuration prompt screens guide you through the minimum setup required for the solar charge controller to operate properly.

Table 2-4 Startup Screens on Charge Controller Front Panel Display

Display	Duration	Description
XW-MPPT60-150	5 seconds	Startup message 1: solar charge controller model number
Ver 01.00 Build 0005	5 seconds	Startup message 2: Firmware version and build numbers. This screen is also available in the Device Menu for referencing during normal operation (see page 3-18).

2. At the first prompt screen, the Battery screen, select a name (such as Bank 1) for the battery bank connected to the solar charge controller.
Selecting a battery connection is important for multiple solar charge controller installations (where units share data over a Xanbus network), because it associates the selected battery bank with each unit.
3. Press Enter to confirm the battery bank.
4. At the Battery Type screen, select the battery type for your system.
5. Press Enter to confirm the battery type.
6. When the Battery Voltage screen appears, check that the solar charge controller has detected the correct system voltage.
7. Press Enter to confirm the detected battery voltage.

Or, if the unit has not automatically detected the voltage, select the correct voltage using the arrow buttons. When the correct battery voltage appears, press Enter.

8. At the Battery Capacity screen, select the battery capacity of your system.
9. Press Enter to confirm the battery capacity.
10. Uncover the PV array and/or apply power with the disconnect or selector switch.

The solar charge controller starts up in sleep mode and waits for a short period to determine that the input voltage is greater than the output voltage. The LCD indicates the solar charge controller mode or any error conditions that may be present (see “Viewing Operating Status” on page 4–2). After the input voltage exceeds the output voltage by the required margin for 10 seconds, the unit begins operating.

Commissioning Multiple Units Without a System Control Panel

When commissioning several solar charge controllers on the same Xanbus network, care must be taken to set a unique device number and the correct battery connection for each unit. The connection is important to define so that system totals and other related information are displayed accurately on each unit's LCD.

Once the first unit is configured, you can copy that configuration to all other units by following the “Copy Config?” prompt on the LCD.

Settings that are copied from one unit to another:

- Battery Type
- Battery Amp Hour Capacity
- Max Charge Rate/Current Limit
- Charge Cycle
- Recharge Voltage
- Max Absorption Time
- Default Battery Temperature
- Nominal Battery Voltage
- DC Out Connection/Battery Bank
- Custom Battery Settings (if Custom Battery type selected):
 - Equalize Support
 - Equalize Voltage
 - Bulk Voltage
 - Absorption Voltage
 - Float Voltage
 - Battery Temperature Compensation

To commission multiple solar charge controllers:

1. Close the DC disconnect or use a selector switch to apply battery power to all of the solar charge controllers at the same time.

The LCD on each unit displays the two startup screens in sequence, as shown in Table 2-4, followed by a prompt screen for you to set the device number.

2. On all the charge controllers, set the device number to a value other than its default value of 00. No two charge controllers can have the same device number. The device number can be set to any number between 01 and 31. For the first solar charge controller, 01 is recommended. If you have two charge controllers, simply set them to 01 and 02.

Note: If it is necessary to reset the solar charge controller to factory default settings, checking that the device number has reverted to 00 will confirm the reset was successful.

After setting the device numbers, a “Copy Config?” prompt screen appears on all of the solar charge controllers. The options available are “Yes” and “No”

3. On the solar charge controller you set to device number 01, select “No.” You will be prompted to enter (as described in steps 2 through 9 in “Commissioning a Single Unit Without a System Control Panel”):
 - Battery connection. The default is Bank 1, and each solar charge controller connected to a common battery bank must be set to the same battery connection.
 - Battery voltage
 - Battery type
 - Battery capacity.
4. The first unit will now have the minimum configuration settings confirmed. If you want to customize other more advanced settings (such as 2-stage or 3-stage charging, or custom battery type settings), it is recommended to do that now as these settings can be automatically copied over to the other solar charge controllers that are yet to be configured.
5. On the next solar charge controller, which should still be displaying the “Copy Config?” prompt screen, select “Yes.” A “Copy Setup From?” screen appears.
6. Select the device number of the first solar charge controller you configured (which should be device number 01), and press Enter.

Note: If you need to check the device number of the unit you previously configured, navigate to the Device Menu and view the Device Number screen. See Figure 3-2, “Complete Configuration Menus” on page 3–4. Note that the entire Device Menu is only visible when the Display Mode is set to Advanced.

The first solar charge controller’s configuration is copied to the second unit and the “Copy Config?” prompt screen disappears.

7. Uncover the PV array and/or apply power with the disconnect or selector switch.

The solar charge controller starts up in sleep mode and waits for a short period to determine that the input voltage is greater than the output voltage. The LCD indicates the solar charge controller mode or any error conditions that may be present (see “Viewing Operating Status” on page 4–2). After the input voltage exceeds the output voltage by the required margin for 10 seconds, the unit begins operating.

Commissioning Units Using a System Control Panel

In systems where an SCP is present, the SCP is intended to be the configuration interface. For information about SCP navigation and menus, see Appendix B, “Conext System Control Panel Menus”.

Commissioning units using an SCP involves three separate procedures:

1. Setting the Device Numbers for all solar charge controllers.
2. Configuring Connections and Charger Settings for the first solar charge controller.
3. Copying settings from the first unit to the other solar charge controller.

To set the Device Numbers for all solar charge controllers:

1. Ensure the Xanbus network is connected to a Xanbus-enabled inverter to provide power to the SCP.
2. Apply battery power to all of the solar charge controllers at the same time. When the solar charge controllers are powered up, they will detect that an SCP is already operating on the network, and be ready for configuration through the SCP. Do not apply PV power at this point.
3. From the Select Device menu on the SCP, select a solar charge controller (each unit should appear as “MPPT60 00” where the 60 stands for 60A, and the 00 is its device number).
4. On the MPPT Setup menu, ensure the Advanced Settings item is displayed. If Advanced Settings are not displayed (and Basic Settings appears as the last item on the menu), press the Enter, up arrow, and down arrow keys together. (See “Advanced menu” on page B–7.)
5. Select Advanced Settings, then select the Multi Unit Config menu. After entering the Multi Unit Config menu, the LCD backlight on the solar charge controller to be configured will flash.
6. On the Multi Unit Config menu, select Dev Number and set it to a number other than 00. Press Enter to confirm the new device number.

The device number can be set to any number between 01 and 31. For the first solar charge controller, 01 is recommended. If you have two charge controllers, simply set them to 01 and 02.
7. Press Exit until the Select Device menu is displayed.

The solar charge controller now appears as MPPT60 01 on the menu.

8. Repeat steps 3 through 7 for the next solar charge controller.

When you have set the device number for all solar charge controllers, you can configure Connections and Charger Settings for the first solar charge controller.

To configure Connections and Charger Settings for the first solar charge controller:

1. On the Select Device Menu, select "MPPT60 01."
2. Navigate to the Multi Unit Config menu and select Connections.
On the Connections menu, you can configure PV In (PV input) and DC Conn (DC output, or the battery bank). If the system has only one battery bank, leave DC Conn at the default setting. The PV In setting allows you to differentiate which array is going to which solar charge controller. This setting is used for status reporting only, not for any internal controls. Setting PV In to a non-default value is optional.
3. Press Exit twice to leave the Connections menu and Multi Unit Config menu.
4. From the Advanced Settings menu, select Charger Settings.
5. Set the Battery Type, Battery Capacity, and any other charger settings required for your system.

While in the Charger menu, ensure that the Nominal Battery Voltage is set correctly (it is shown as Batt Voltage and appears as the last item on the menu). If you select "Custom" for your Battery Type, you can further configure the Bulk, Absorption, Float and other settings for the charge cycle. The first unit should now be configured properly for your system.

If multiple units are installed, you can now copy the first unit's configuration over to other units.

To copy the solar charge controller setup to another unit:

1. On the SCP, press Exit to leave the Advanced Settings menu and view the Select Device menu.
2. On the Select Device Menu, select the next solar charge controller for configuration.
3. On the Advanced Settings menu, select Copy From, then select the solar charge controller you want to copy from. You should select the unit with the device number that matches the first unit you configured.
4. Press Enter.

The settings are automatically copied from the selected unit.

Note: The Copy From command will not give you any indication that it has completed its task. However, you can quickly check for yourself that the charger settings you have chosen have been copied properly by viewing some of the settings you originally configured.

5. Uncover the PV array and/or apply power with the disconnect or selector switch.

The solar charge controller starts up in sleep mode and waits for a short period to determine that the input voltage is greater than the output voltage. After the input voltage exceeds the output voltage by the required margin for 10 seconds, the unit begins operating.

3

Configuration

Chapter 3 contains information and procedures to configure the Conext MPPT Solar Charge Controller.

It includes:

- Configuration Menus
- Configuring Battery Characteristics and Battery Charging
- Configuring Charge Controller Input
- Configuring the LCD
- Resetting to Factory Defaults

Configuring the Charge Controller

The following sections describe how to configure the Conext MPPT Solar Charge Controller (charge controller) for the desired application and function.

The solar charge controller is configured using the four buttons on the front of the unit.

Table 3-1 Charge controller buttons

Button	Function
Enter	<ul style="list-style-type: none">• Displays the next screen level. For example, pressing Enter from the Battery Menu selection screen displays the first configurable item on the Battery menu.• Selects and confirms selection of a menu item
Up arrow	<ul style="list-style-type: none">• Displays previous menu or menu item. For example, pressing the Up arrow from the Battery Menu selection screen displays the History Menu selection screen.• Increases a selected value
Down arrow	<ul style="list-style-type: none">• Displays the next menu or menu item. For example, pressing the Down arrow from the Battery Menu selection screen displays the Input Menu selection screen.• Decreases a selected value
Exit	<ul style="list-style-type: none">• Cancels selection of a menu item• Displays the previous screen level. For example, pressing Exit from the Equalization Reminder screen on the Battery Menu displays the Battery Menu selection screen. Pressing Exit again displays the top-level operating screens.

Configuration Menus

The menus for setup and monitoring solar charge controller performance are shown in Figure 3-1 and Figure 3-2.

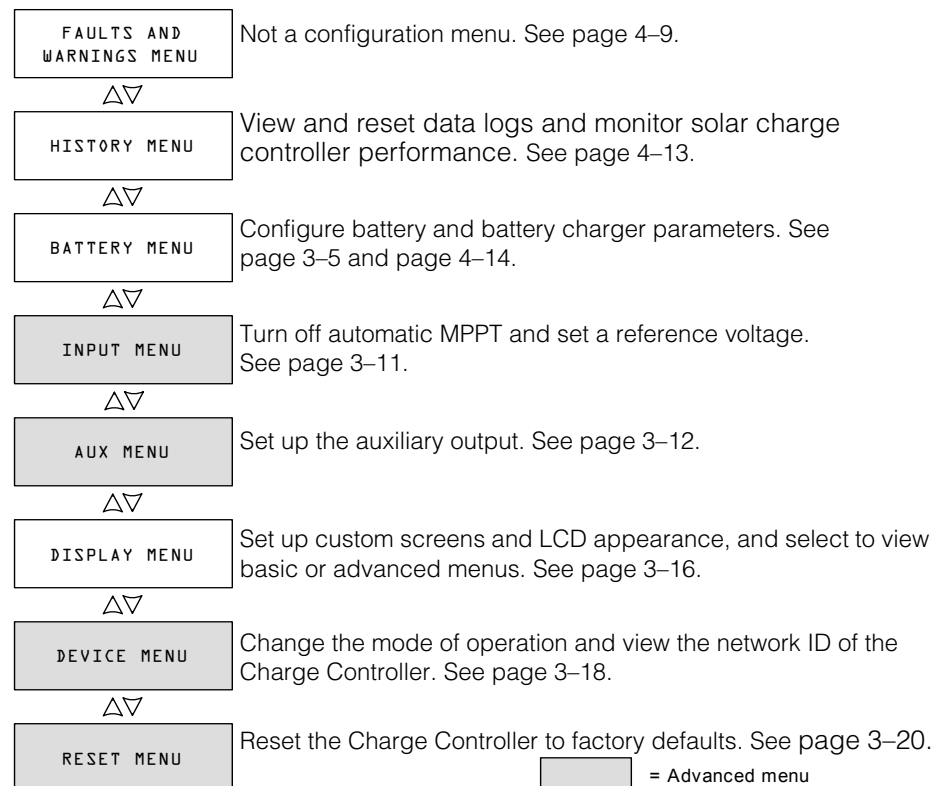

Figure 3-1 Configuration Menu Selection Screens

Basic and Advanced Menus

The menu can be viewed in basic and advanced formats. Basic menus contain items you may have to view and adjust on a routine basis. Advanced menus contain items intended for service personnel and one-time setup, such as auxiliary output configuration and defining custom battery types.

The solar charge controller is shipped from the factory with only basic menu items enabled. You can choose to view the basic or advanced menus on the Display Menu (see “Configuring the LCD” on page 3–16).

The Input Menu, Auxiliary Menu, Device Menu, and Reset Menu are advanced menus only, as are some items on the History Menu and Battery Menu.

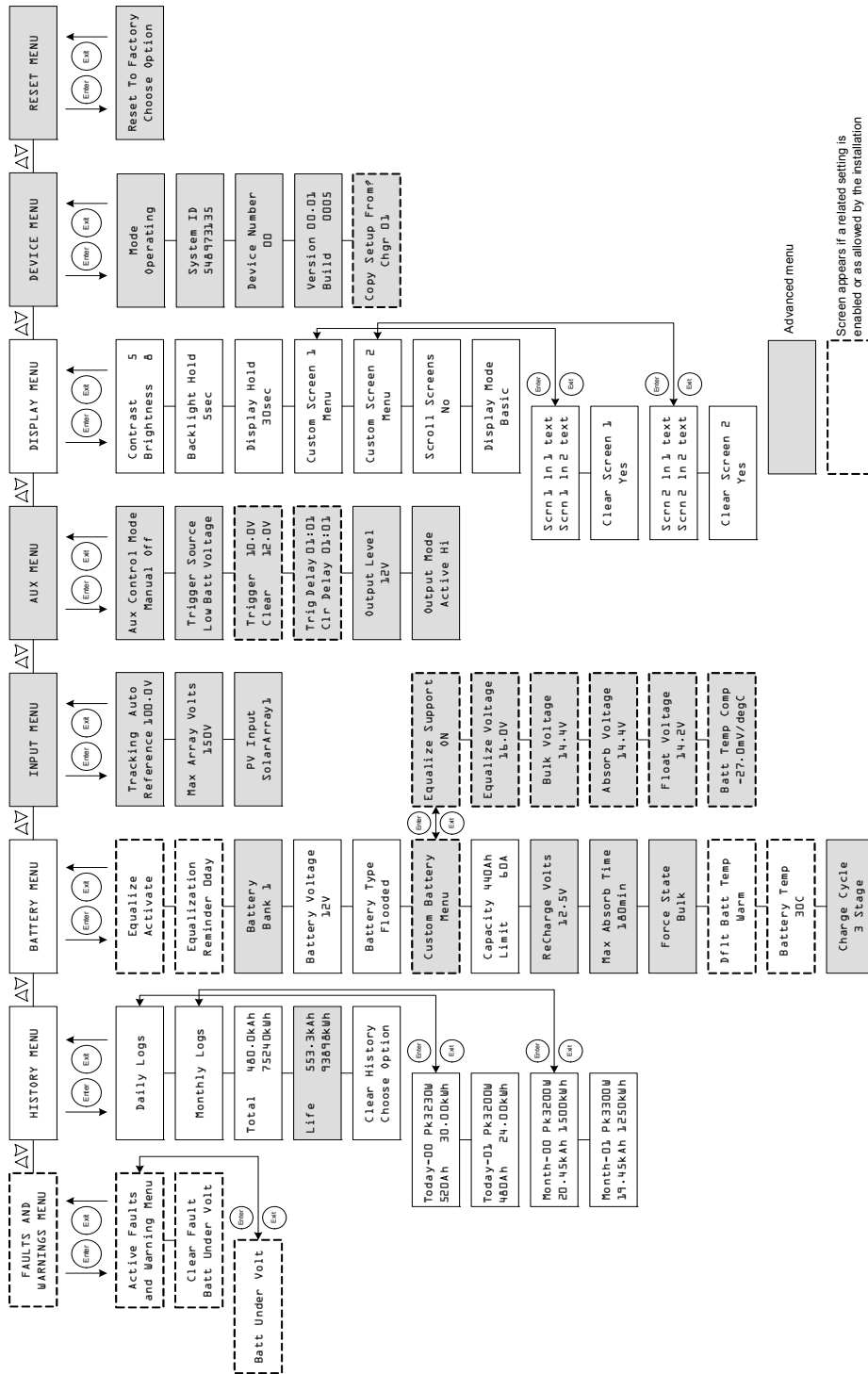

Figure 3-2 Complete Configuration Menus

Configuring Battery Characteristics and Battery Charging

On the Battery Menu you can:

- Start battery equalization
- Configure your battery type, voltage and amp-hour capacity
- Configure a custom battery type by adjusting settings for each battery charge stage and fine-tuning temperature-compensated charging
- Monitor battery temperature.

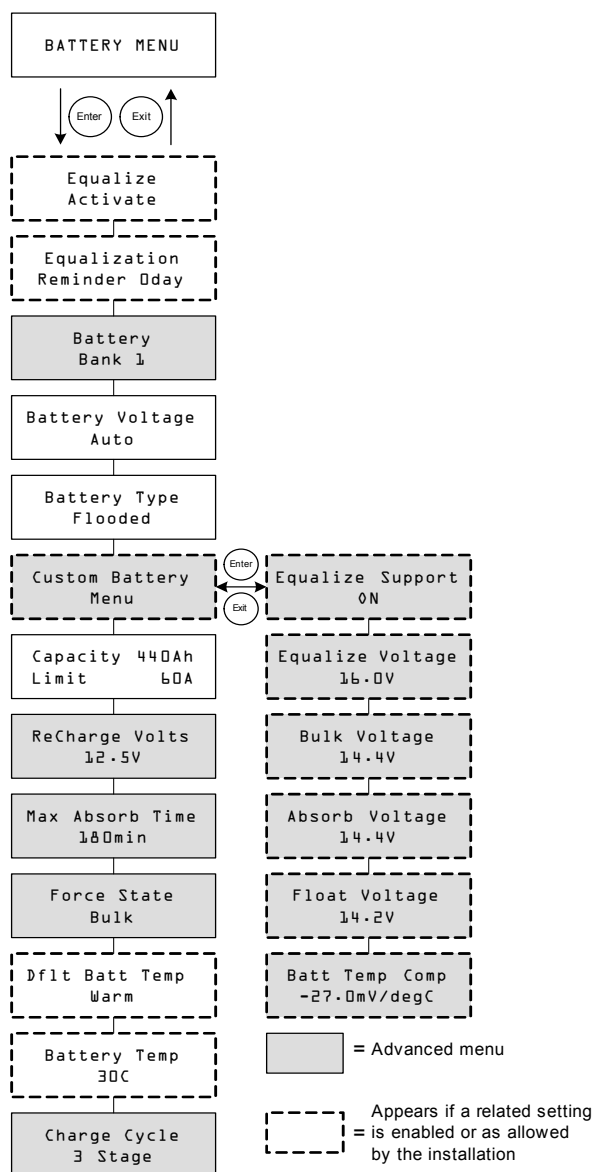

Figure 3-3 Battery Menu

Table 3-2 Battery Menu Values

Setting	Values	Default	Description
Equalize Activate	Activate/Stop	Activate	Enables or disables Battery Equalization. If the Battery Type is set to GEL or AGM, this setting is disabled.
Equalization Reminder Dd	0–365 d(ays)	0 d	Sets a reminder that notifies you when the battery needs equalizing. If set to 0, the reminder is disabled.
Battery Bank 1	1–12	1	Selects the battery bank connected to the solar charge controller. This is important for networked installations, where multiple devices must coordinate their activity around common DC connections.
Battery Voltage 12V	12V, 24V, 36V, 48V, 60V	n/a	Selects your battery voltage. Select the nominal voltage level that matches your system's battery voltage.
Battery Type Flooded	Flooded, GEL, AGM, Custom	Flooded	Selects your battery type. Selecting Custom allows you to adjust the Equalize, Bulk, Absorption, and Float Voltage settings. Battery temperature compensation can also be adjusted on the Custom Battery menu. The Custom option is available only when advanced menus are displayed.
Custom Battery Menu	n/a	n/a	Press Enter to display the Custom Battery menu and configure a custom battery type. See "Setting a Custom Battery Type" on page 3–8.
Capacity 440Ah Limit 60.0A	50–2000Ah 6.0–60.0A	440Ah 60.0A	Line 1: Sets the amp-hour capacity of your battery bank. Line 2: Sets the charging current limit.

Table 3-2 Battery Menu Values

Setting	Values	Default	Description
ReCharge Volts 12.5V	12V: 10.0–13.5V 24V: 20.0–27.0V 36V: 30.0–40.5V 48V: 40.0–54.0V 60V: 50.0–67.5V	12.5V 25.0V 37.5V 50.0V 62.5V	Sets the voltage at which the charger transitions from Float or No Float back to Bulk, or from Absorption back to Bulk.
Max Absorb Time 180min	120–360 min	180 min	Sets the maximum time spent at a constant voltage (the setting for Absorption voltage) during the absorption stage. This setting does not control the duration of the entire Absorption stage.
Force State Bulk	Bulk, Float, No Float	Bulk	Manually sets the charge stage to bulk, float, or no float.
Dflt Batt Temp Warm	Cold, Warm, Hot	Warm	Sets the default battery temperature for compensation when the BTS is not connected. Cold is suitable for temperatures of around 10 °C (50 °F), Warm for 25 °C (77 °F), and Hot for 40 °C (104 °F). This screen appears only when a BTS is not connected.
Battery Temp 30C	-40–65 C	n/a	Shows the battery temperature (in Celsius) detected by the BTS. This screen appears only when a BTS is connected.
Charge Cycle 3 Stage	3 Stage, 2 Stage No Float	3 Stage	Selects the charging cycle (or algorithm)—3 Stage (Bulk/Absorption/Float) or 2 Stage (Bulk/Absorption/No Float).

Setting a Custom Battery Type

⚠ WARNING
<p>HAZARD OF FIRE OR EXPLOSION</p> <p>Incorrect settings for speciality batteries, such as lithium ion, can cause dangerous battery over-charging. Always connect the Battery Temperature Sensor (BTS). Custom battery settings should be configured by qualified personnel only.</p> <p>Failure to follow these instructions can result in death or serious injury.</p>

⚠ CAUTION
<p>EQUIPMENT DAMAGE</p> <p>To avoid damaging your batteries during charging or equalization, consult your battery manufacturer and associated documentation before setting a custom battery type.</p>

The Custom Battery menu allows you to adjust charging and equalization voltage for lithium ion and other specialty batteries whose specifications fall outside of the default settings for the battery types the solar charge controller offers.

You can also adjust the temperature compensation constant for the BTS on the Custom Battery menu.

Important:

- Setting the Battery Type to Custom is possible only when advanced menus are displayed.
- The Custom Battery menu is displayed only when the Battery Type is set to Custom.
- All settings for configuring a Custom battery type are based on the default settings for a Flooded battery type.

The following table describes the options available on the Custom Battery menu.

Table 3-3 Custom Battery Menu Values

Setting	Values	Default	Description
Equalize Support ON	ON, OFF	ON	Selects whether Equalization will be allowed or not for the Custom battery type.

Table 3-3 Custom Battery Menu Values

Setting	Values	Default	Description
Equalize Voltage 16.0V	12V: 13.5–16.0V	16.0V	Selects the equalization voltage (consult your battery manufacturer for equalization voltage setting). This screen is hidden if Equalize Support is OFF.
	24V: 27.0–32.0V	32.0V	
	36V: 40.5–48.0V	48.0V	
	48V: 54.0–64.0V	64.0V	
	60V: 67.5–72.0V	72.0V	
Bulk Voltage 14.4V	12V: 10.0–16.0V	14.4V	Sets the bulk voltage for a custom battery type.
	24V: 20.0–32.0V	28.8V	
	36V: 30.0–48.0V	43.2V	
	48V: 40.0–64.0V	57.6V	
	60V: 50.0–72.0V	72.0V	
Absorb Voltage 14.4V	12V: 10.0–16.0V	14.4V	Sets the absorption voltage for a custom battery type.
	24V: 20.0–32.0V	28.8V	
	36V: 30.0–48.0V	43.2V	
	48V: 40.0–64.0V	57.6V	
	60V: 50.0–72.0V	72.0V	
Float Voltage 13.5V	12V: 10.0–16.0V	13.5V	Sets the float voltage for a custom battery type.
	24V: 20.0–32.0V	27.0V	
	36V: 30.0–48.0V	40.5V	
	48V: 40.0–64.0V	54.0V	
	60V: 50.0–72.0V	67.5V	
Batt Temp Comp -27mV/degC	12V: -45–0mV/degC	-27mV	Battery temperature compensation for a custom battery type. This setting is the reference that the BTS uses to adjust the charging voltage when the temperature falls above or below 25 °C. See “Battery Temperature Compensation”.
	24V: -90–0mV/degC	-54mV	
	36V: -135–0mV/degC	-81mV	
	48V: -180–0mV/degC	-108mV	
	60V: -225–0mV/degC	-135mV	

See “Default Battery Charging Settings” on page A–2 for default settings for standard battery types.

▲ CAUTION**EQUIPMENT DAMAGE**

The solar charge controller is incapable of determining battery type and cannot warn against or disallow incorrect settings. The settings for bulk, absorption, float and equalization charge must be checked carefully against the battery specifications. Incorrect settings may damage the battery or shorten battery life.

Battery Temperature Compensation

When battery charging voltages are compensated based on temperature, the charge voltage will vary depending on the temperature.

Temperature compensation can be accomplished automatically by using a BTS. The BTS attaches directly to the side of one of the batteries in the bank and provides precise battery temperature information.

See “Installing the Battery Temperature Sensor” on page 2–28 for detailed instructions on how and where to install the BTS.

If a BTS is installed, the charge controlling process will be automatically adjusted for the battery temperature. The solar charge controller uses the following coefficients to adjust the charging voltage:

- Flooded Lead-Acid and Gel-Type Batteries (12 V nominal):
-27 mV per degree Celsius
- Absorbed Glass Mat (AGM)-Type Batteries (12 V nominal):
-21 mV per degree Celsius

If using a BTS, when the battery temperature drops below 77°F (25°C), the regulation voltage setting automatically increases. When the temperature rises above 77°F (25°C) the regulation battery voltage setting automatically decreases. The temperature range where compensation is applied is between 0°C and 50°C. Outside of this temperature range, the compensation value is clamped at the corresponding value for either 0°C or 50°C.

If a BTS is not installed, you can configure the solar charge controller to use one of three temperature compensated charge settings:

- Cold—10°C (50°F)
- Warm—25°C (77°F)
- Hot—40°C (104°F)

If significant seasonal variations are common in your area, you will have to change the settings during the year to ensure optimal battery charging.

Configuring Charge Controller Input

On the Input Menu you can disable automatic maximum power point tracking and configure the reference voltage level at which the solar charge controller will operate the array. Configuring the reference voltage is not required for normal operation, but can be useful for non-PV applications or for testing purposes.

The Input Menu is an advanced menu item. To display the Input Menu, go to the Display Menu, view the Display Mode screen and select Advanced. See “Configuring the LCD” on page 3-16.

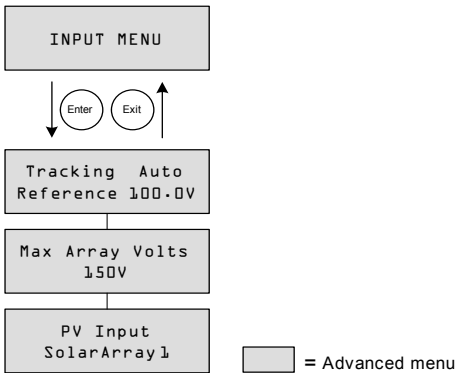

Figure 3-4 Input Menu

Table 3-4 Input Menu Values

Setting	Values	Default	Description
Tracking Auto Reference 100.0V	Auto, Manual 0.0–150.0V	Auto, n/a	Line 1: Enables (Auto) or disables (Manual) MPPT. Line 2: When tracking is set to Manual, you can select the reference voltage at which solar charge controller operates the array. When tracking is set to Auto, the reference voltage updates to reflect tracking activity.
Max Array Volts 150V	0–200	n/a	Records the maximum input voltage from the array during the lifetime of the solar charge controller. You cannot reset this screen.
PV Input	SolarArray 1–16	SolarArray 1	Sets the input connection for the solar charge controller.

Configuring the Auxiliary Output

The Aux Menu allows you to enable and configure the auxiliary output. The auxiliary output provides between 5 and 13 volts DC (configurable) and up to 200 milliamps to power a relay, indicator light, vent fan, or alarm.

The Aux Menu is an Advanced Menu item. To display the Aux Menu, go to the Display Menu, view the Display Mode screen and select Advanced. See “Configuring the LCD” on page 3–16.

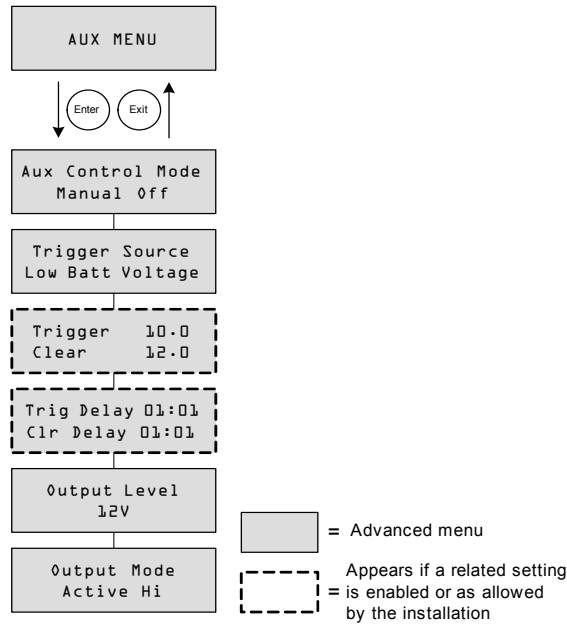

Figure 3-5 Aux Menu

Table 3-5 Aux Menu Values

Setting	Values	Default	Description
Aux Control Mode ManualOff	Manual Off, Manual On, Automatic	Manual Off	Sets the operating mode for the auxiliary output. When set to Automatic, the auxiliary output will turn on or off according to the selected Trigger Source. You can turn the auxiliary output on or off at any time by selecting ManualOn or ManualOff.

Table 3-5 Aux Menu Values

Setting	Values	Default	Description
Trigger Source Low Batt Voltage	Low Batt Voltage, Hi Batt Voltage, Hi Array Voltage, Low Batt Temp, Hi Batt Temp, Hi Heat Sink Temp, Fault	Low Batt Voltage	Selects the desired condition to activate the Aux Output.
Trigger 10.0 Clear 12.0	Depends on Trigger Source (see Table 3-6)		<p>Line 1: Selects the battery or array voltage to activate Aux Output. If the selected Trigger Source is Hi Batt Temp, Low Batt Temp, or Hi Heat Sink Temp, this screen displays Trigger Temperature Level in degrees Celsius.</p> <p>Line 2: Selects the battery or array voltage to turn off the Aux Output. If the selected Trigger Source is Hi Batt Temp, Low Batt Temp, or Hi Heat Sink Temp, this screen displays Clear Temperature Level in degrees Celsius.</p> <p>This screen is hidden if the trigger source is set to Fault.</p>
Trig Delay 00:00 Clr Delay 00:00	00:00–09:59 (mm:ss format)	00:00	<p>Line 1: Selects how long the selected trigger source must be active before the Aux Output activates. This can avoid unnecessary triggering by momentary loads.</p> <p>Line 2: Selects how long the trigger condition must remain inactive before the Aux Output turns off.</p> <p>This screen is hidden if the trigger source is set to Fault.</p>
Output Level 12V	5V–13V	12V	Selects the active high auxiliary output voltage (the active low output voltage is 0 V).

Table 3-5 Aux Menu Values

Setting	Values	Default	Description
Output Mode Active Hi	Active Hi, Active Lo	Active Hi	Sets the mode (polarity) of the aux output. When Active Hi is selected, the aux output turns on when the trigger source is present. When Active Lo is selected, the aux output turns off when the trigger source is present.

Important: If the selected trigger source is Low Batt Voltage or Hi Batt Voltage, changing the nominal battery voltage setting will reset the Trigger Voltage Level and Clear Voltage Level settings to their default values.

Trigger Source Descriptions

Low Batt Voltage Activates the auxiliary output when the battery voltage falls below the trigger setting for the trigger delay time. Deactivates the auxiliary output when the battery voltage rises above the clear setting for the clear delay time. Use this setting if you want the auxiliary output to control a relay to disconnect loads from a battery that is nearly discharged, or to activate a low-battery-voltage alarm such as a buzzer or light.

Hi Batt Voltage Activates the auxiliary output when the battery voltage rises above the trigger setting for the trigger delay time. Deactivates the auxiliary output when the battery voltage falls below the clear setting for the clear delay time. This setting is useful for:

- installations that have another external charging source such as a wind generator or hydro generator connected directly to the batteries. The solar charge controller auxiliary output can control a relay to disconnect the external charging source from the battery when the battery is in danger of being overcharged, or control a relay to turn on a diversion load.
- activating a high-battery-voltage alarm such as a buzzer or light.
- activating a vent fan to disperse hydrogen from the battery compartment when the batteries reach their gassing voltage.

Hi Array Voltage Activates the auxiliary output when the PV array voltage rises above the trigger setting for the trigger delay time. Deactivates the auxiliary output when the PV array voltage falls below the clear setting for the clear delay time. Use this setting if you want the auxiliary output to control a series latching relay to disconnect the PV array from the solar charge controller or trigger an alarm when the PV array voltage exceeds the trigger setting (the solar charge controller maximum operating voltage is 140 Vdc).

You can also use the Hi Array Voltage trigger to control a relay to turn on a night light. Set the Trigger Level to your nominal battery voltage and the Output Mode to Active Lo. This will energize the relay and turn on the light whenever the array voltage is insufficient to charge the battery bank.

Low Batt Temp Activates the auxiliary output when the battery temperature falls below the trigger setting for the trigger delay time. Deactivates the auxiliary output when the battery temperature rises above the clear setting for the clear delay time. Battery temperature is measured with a battery temperature sensor. Do not use this setting if a battery temperature sensor is not installed. With this setting, the auxiliary output can turn on an indicator alarm if the batteries are too cold. A battery with frozen electrolyte will not accept a charge.

Hi Batt Temp Activates the auxiliary output when the battery temperature rises above the trigger setting for the trigger delay time. Deactivates the auxiliary output when the battery temperature falls below the clear setting for the clear delay time. Battery temperature is measured with a battery temperature sensor. Do not use this setting if a battery temperature sensor is not installed. With this setting, the auxiliary output can turn on a fan to cool the battery compartment.

Hi Heat Sink Temp Activates the auxiliary output when the solar charge controller heat sink temperature rises above the trigger setting for the trigger delay time. Deactivates the auxiliary output when the heat sink temperature falls below the clear setting for the clear delay time. This setting can be used to trigger an alarm.

Fault Activates the auxiliary output when a fault occurs. This setting can be used to turn on an alarm or indicator light. When Fault is selected as the trigger source, there is no programmable trigger level or clear level. You also cannot select a specific fault as an auxiliary output trigger.

Trigger Source Configurable Ranges

This table contains the available configuration ranges and default settings for each Trigger Source. The units, whether voltage or temperature, vary according to the Trigger Source selected. If the selected Trigger Source is a Battery Voltage, the range also varies according to the nominal battery voltage of your system.

Important: Changing the Trigger Level resets the auxiliary output. If an auxiliary output trigger is active, changing the trigger level will clear the trigger.

Table 3-6 Trigger Source Configuration Ranges

Trigger Source	Range	Default Trigger	Default Clear
Low Batt Voltage	12V: 5–13V	11V	12V
	24V: 10–26V	22V	24V
	36V: 15–39V	33V	36V
	48V: 20–52V	44V	48V
	60V: 25–65V	55V	60V

Table 3-6 Trigger Source Configuration Ranges

Trigger Source	Range	Default Trigger	Default Clear
Hi Batt Voltage	12V: 12–16V	14V	13V
	24V: 24–32V	28V	26V
	36V: 36–48V	42V	39V
	48V: 48–64V	56V	52V
	60V: 60–80V	70V	65V
Hi Array Voltage	10–145V	140V	130V
Hi Batt Temp	30.0–60.0 C	45.0 C	35.0 C
Low Batt Temp	-30.0–10.0 C	0.0 C	5.0 C
Hi Heat Sink Temp	50–95 C	75 C	70 C

Configuring the LCD

On the Display Menu you can adjust the screen settings for the LCD, define Custom Screens, and select to view Basic or Advanced menus.

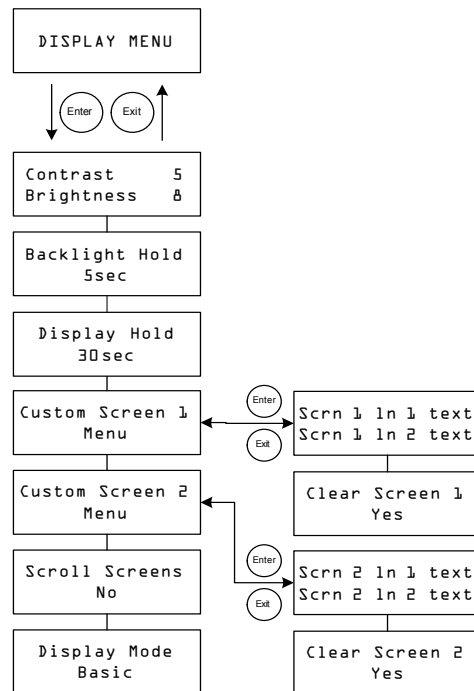

Figure 3-6 Display Menu

Table 3-7 Display Menu Values

Setting	Values	Default	Description
Contrast 5	1–9	5	Line 1: Adjusts screen contrast.
Brightness 8	1–9	8	Line 2: Adjusts backlight brightness.
Backlight Hold 5sec	0, 5sec, 10sec, 30sec, 1min, Always On	5 sec	Adjusts how long the backlight stays on after the last key press. When 0 is selected, the backlight never turns on. ^a
Display Hold 30sec	10sec, 30sec, 1min, 5min, 10min	30sec	Adjusts how long the LCD displays the current screen before returning to the default home screen.
Custom Screen 1 Menu	n/a	n/a	Allows you to define a custom screen. Press Enter to enter Custom Screen text.
Custom Screen 2 Menu	n/a	n/a	Allows you to define a custom screen. Press Enter to enter Custom Screen text.
Scroll Screens Yes	Yes, No	No	Sets the home screens to scroll automatically (once every 4 seconds).
Display Mode Basic	Basic, Advanced	Basic	Displays basic or advanced configuration menus.

a.Note: It is not recommended to leave the Backlight Hold setting at “Always On” for extended periods of time. The backlight consumes an extra 0.5 watts of power from the battery. As well, turning the backlight off when not in use increases the lifespan of the backlight.

Device Menu

On the Device Menu you can change the operating mode of the solar charge controller and view the solar charge controller's device number. Both these activities may be necessary for service or diagnostics, or when adding another Xanbus-enabled device to the system.

The Device Menu is an advanced menu item. To display the Device Menu, go to the Display Menu, view the Display Mode screen and select Advanced.

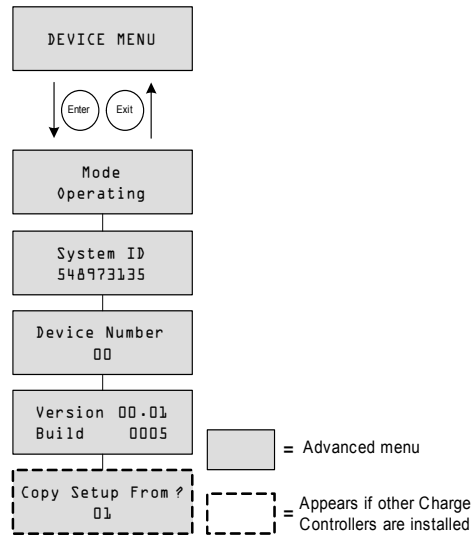

Figure 3-7 Device Menu

Table 3-8 Device Menu Values

Setting	Values	Default	Description
Mode Operating	Operating, Standby, Hibernate	Operating	<p>Operating is the normal mode for the unit.</p> <p>Standby disables the output by disconnecting the main power circuit from the battery. The unit cannot charge. The unit still draws some power from the battery to operate. The LCD stays on.</p> <p>Hibernate performs the same actions as Standby, but it also disables all Xanbus network communications.</p>
System ID 548973135	n/a	n/a	Xanbus system ID.
Device Number 00	00 to 31	00	Displays the device number for the solar charge controller. This number is selected when the solar charge controller is first powered up, and uniquely identifies devices of the same type (Charge Controllers, Inverter/Chargers, control panels, and so on) in a networked installation.
Version 01.00 Build 0005	n/a	n/a	Firmware version and firmware build number. This screen is identical to the screen shown at startup.
Copy Setup From? 01	All available device numbers.	01	<p>Enables one-step configuration of a new solar charge controller in a multi-unit installation. Select the device number of the unit you wish to copy the setup from. This screen is hidden when no compatible devices are found.</p> <p>The “Copy Setup From?” command copies all Battery Menu settings and Custom Battery Menu settings from the selected unit.</p>

Resetting to Factory Defaults

On the Reset Menu you can restore factory default settings. The Reset Menu is an advanced menu item. To display the Reset Menu, go to the Display Menu, view the Display Mode screen and select Advanced.

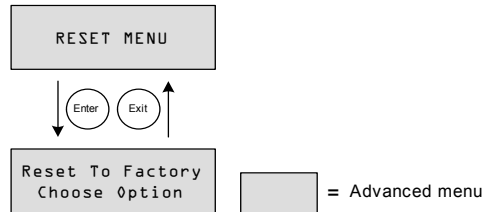

Figure 3-8 Reset Menu

Table 3-9 Reset Menu Values

Setting	Values	Default	Description
Reset to Factory Choose Option	Choose Option, Aux Settings, Everything	Choose Option	Returns configurable settings to factory defaults. Choose Option is a prompt to select a value. You must select this before selecting which value (Aux Settings or Everything) to reset. Aux Settings resets all values on the Aux Menu. Everything resets all configurable values to factory defaults.

Selecting Everything resets all of the:

- Configurable battery/charger settings
- Configurable Auxiliary Output settings
- Configurable display settings (including contrast, backlight brightness, and scrolling screens)
- Daily and monthly history log entries
- Custom LCD screens
- Total production readings for the unit (not including the lifetime production values).

4

Operation

Chapter 4 contains information about the operation of the Conext MPPT Solar Charge Controller.

It includes:

- Viewing Operating Status
- Monitoring Charge Controller Operation
- Battery Equalization

Viewing Operating Status

The Conext MPPT Solar Charge Controller (solar charge controller) has four buttons and a 2-line, 16 character liquid crystal display (LCD) for configuration and displaying system information and operating status.

- When in Charge Control mode the LCD shows the output power, voltage and current (and additional information as shown in Figure 4-1).
- When a fault condition exists, the LCD shows “Fault Active.”
- When battery equalization is taking place, the LCD shows “Equalization Pending” (when bulk/absorption charging prior to equalization) and “mm:ss remaining” while applying the equalization charge.

LCD Screens and What They Mean

The front panel display shows different message screens during startup and normal operations. Figure 4-1 shows the sequence in which the Startup and Operating screens are displayed or can be viewed.

All of these message screens are described in more detail in the following sections.

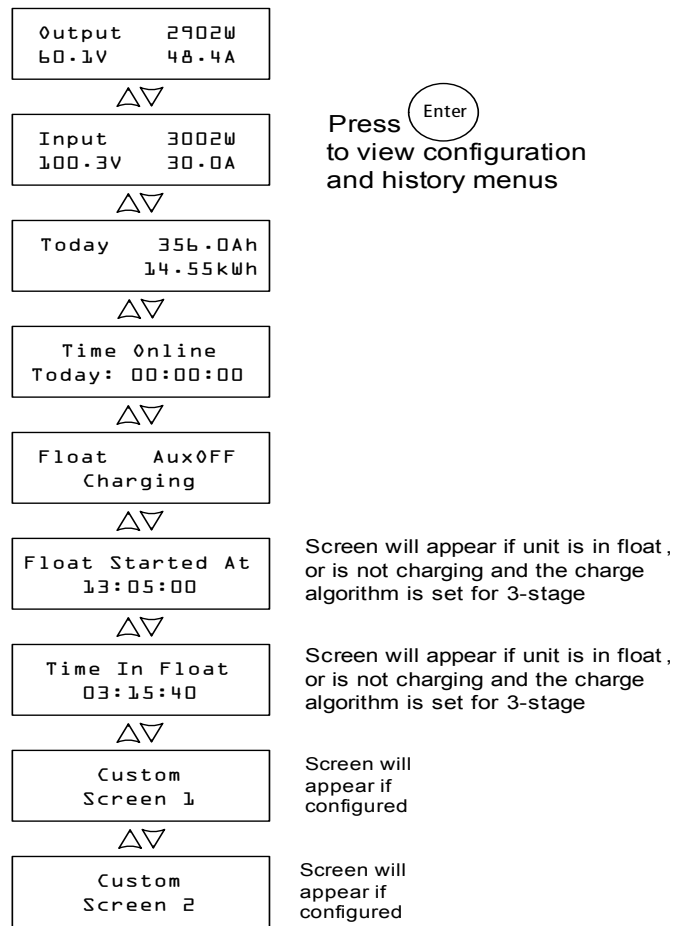

Figure 4-1 Operating Screens

Normal Operation

All readings on the solar charge controller LCD are refreshed every two seconds. A default top-level display is available at all times (see Table 4-1). The additional screens can be displayed by pressing the down arrow or up arrow button. You can also configure the solar charge controller to scroll through each operating screen in sequence (changing every four seconds). See “Configuring the LCD” on page 3-16.

Table 4-1 Default Operation Screen

Display ^a	Description
Output 2902W 60.1V 48.4A	Power being produced by the solar charge controller now. Measured output voltage and output current.

a.All numbers in this table and following tables are examples only. Your unit's details and performance data will vary.

If there is sufficient energy from the PV array, the default operation screen is displayed while the solar charge controller is charging or not charging (in the “no float” stage when configured for two-stage charging).

When more than one solar charge controller is installed and connected to the Xanbus network, the default operation screen appears as shown in Table 4-2.

Table 4-2 Multi-Unit Default Operation Screen

Display	Description
System 23825W 55.6V 428.5A	Power being produced by the system now. Total measured output voltage and output current of all units in the system.

You can view more operation screens by pressing the down arrow button. The screens appear in the order shown in Table 4-3.

Each screen is displayed for a maximum of 30 seconds. If you do not press a button during that time period, the LCD shows the default operation screen again.

Table 4-3 Other Operation Screens

Display	Description
System 4500Ah Today 247.5kWh	Accumulated amp-hours and kilowatt-hours produced by multiple solar charge controllers today. This screen appears only when multiple solar charge controllers are installed in a network.
Input 3002W 100.3V 30.0A	Measured input power, voltage, and current.
Today 356.0Ah 22.56kWh	Accumulated amp-hours and kilowatt-hours produced today by the individual unit.
Time Online Today: 00:00:00	Time the unit has been producing power today, in hours, minutes, and seconds.
Float AuxOFF Charging	<p>This Status screen changes according to the state of the solar charge controller.</p> <p>Line 1: Charge stage and auxiliary output state (ON or OFF). See “Charge Stages” on page 4–6.</p> <p>Line 2: Dynamic text that changes depending on unit state, warning or fault status, or equalization mode. See “Dynamic Text” on page 4–7.</p> <p>When equalizing, when a fault or warning is active, or when input voltage is low, this screen replaces the top-level default operation screen.</p>
Float Started At 00:00:00	<p>If a time source is available on the network (for example if a Conext System Control Pane (SCP), Conext XW+ inverter/charger, or Conext ComBox is on the Xanbus network), this screen will be showing the clock time that the unit entered Float (in hh:mm:ss and 24 hour format). If no time source is available on Xanbus, this screen, will show the value that the Time Online counter was at when the unit transitioned to Float.</p> <p>This screen is only visible if the unit is either in float, or is not charging and the charge algorithm is set for 3-stage (not set for No Float charging). If the unit is in bulk, absorb, no float, or equalize, this screen is hidden.</p>
Time In Float 00:00:00	<p>This screen displays the elapsed time that the unit has been in float in hh:mm:ss format.</p> <p>This screen is only visible if the unit is either in float, or is not charging and the charge algorithm is set for 3-stage (not set for No Float charging). If the unit is in bulk, absorb, no float, or equalize, this screen is hidden.</p>
Custom Screen 1	User-defined custom screen text (configured on the Display Menu). This screen only appears if it has been configured.

Table 4-3 Other Operation Screens

Display	Description
Custom Screen 2	User-defined custom screen text (configured on the Display Menu). This screen only appears if it has been configured.

Charge Stages

The charge stages displayed on the LCD are described in Table 4-4.

Table 4-4 Charge Stages

Text	Description
Bulk	<p>Batteries are charging at the maximum current output of the DC source.</p> <p>If the solar charge controller shuts down because of low input voltage, the unit restarts in bulk mode. This means the solar charge controller starts in bulk at the beginning of every day, regardless of the present battery voltage. If the batteries are charged already, the bulk/absorption cycle finishes after a short period and the unit transitions to float/no float (depending on Charge Cycle configuration).</p>
Absorb	After transitioning from bulk mode, the solar charge controller holds the battery voltage at the absorption voltage setting and the current gradually declines as the battery capacity is reached. The solar charge controller stops absorption charging when one of two conditions are met, as described in “Absorption Stage” on page 1–5.
Float	Battery voltage is held at the float voltage setting. When the battery voltage drops below the ReCharge Volts setting for a cumulative period of 1 minute, a new bulk cycle will be triggered.
No Float	The charger does not output any power during this stage. When the battery voltage drops below the ReCharge Volts setting for a cumulative period of 1 minute, a new bulk cycle is triggered.
Equalize	<p>A deliberate overcharge designed to return each battery cell to optimum condition by reducing sulfation and stratification in the battery. An equalization charge lasts one hour.</p> <p>During the Equalize stage, this screen becomes the top-level screen. The screen displays the equalization time remaining in minutes and seconds.</p>
ChgrOff	No charging is occurring because the input power from the PV array has fallen below the battery voltage.

Dynamic Text

The text that appears on the second line of the charge mode screen is described in Table 4-5.

Table 4-5 Dynamic Text

Text	Appears When...
Charging	The charge stage is Bulk, Absorb, or Float.
Not Charging	Two-stage charging is selected and the solar charge controller is in the No Float stage.
Warning Active	A warning condition is present (see Active Faults and Warnings screen). For more information about the warning, press Enter to view the Active Faults and Warnings screen.
Fault Active	A fault condition is present (see Active Faults and Warnings screen). For more information about the fault, press Enter to view the Active Faults and Warnings screen.
Equalize Due	The Equalize Reminder is set and the equalize reminder time has elapsed.
Equalize Pending	Equalization is activated, but equalization has not begun because the unit is still in bulk or absorption.
mm:ss Remaining	Equalization has begun, indicating how much time remains until equalization is complete.
Standby Mode	The MPPT is off because the solar charge controller has entered Standby mode through the Device Menu or the SCP.
Hibernate	The MPPT is off and Xanbus communications have stopped because the solar charge controller has entered Hibernate mode through the Device Menu or the SCP.
Restart Pending	The solar charge controller is ready to restart but waiting for the timeout period to expire. This condition is normally only observed at dusk and dawn.
Low Light	The solar charge controller cannot charge because the PV array voltage is too low. ^a The Low Light message can appear during any charge stage.
Thermal Derating	The solar charge controller is thermally derating its output because its internal temperatures have exceeded their recommended levels. This condition should only happen if the unit is operating at full power and the ambient temperature around the unit is very high (exceeding 45°C).

a. Battery voltage plus a factor of 0.25 V per 12 V. For example, in a 24 V system, if the battery voltage is 27.0 V and the PV array is producing 27.4 V, the Low Light message appears. The Low Light message clears when the input voltage rises above the battery voltage plus a factor of 1 V per 12 V.

Monitoring Charge Controller Operation

During operation, you may want to view Active Fault and Warning messages and logged power production data. This information is available on the configuration and history menus.

To view configuration and history menus, press Enter from any Operating screen.

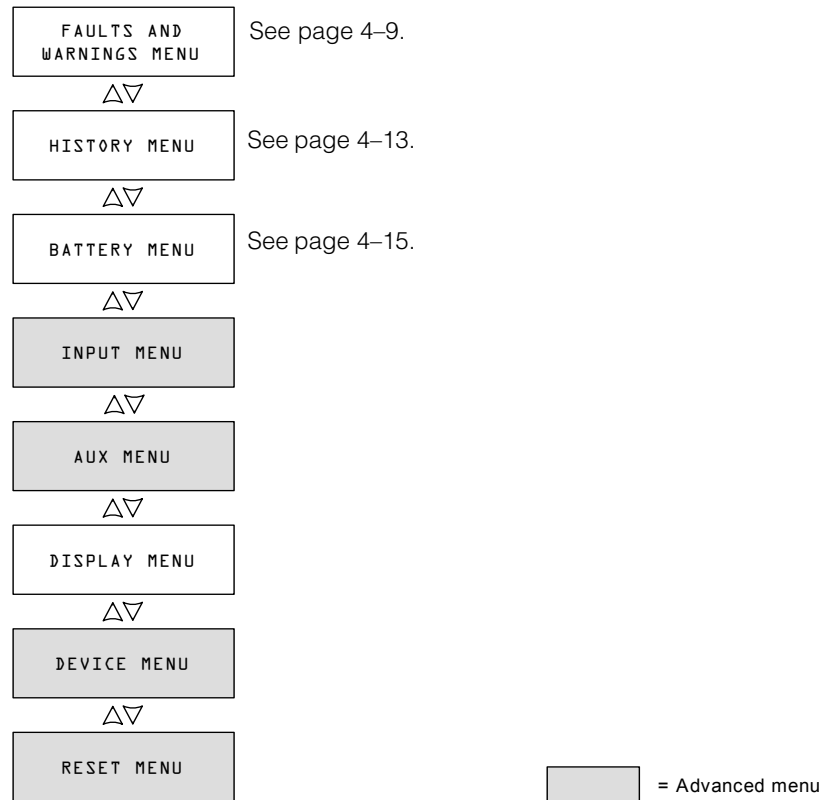

Figure 4-2 Configuration and History Menus

Viewing Active Faults and Warnings

You can view active faults and warnings from the Faults and Warnings Menu.

Note: The Faults and Warnings menu is visible only when the solar charge controller has one or more active faults or warnings.

Warning messages indicate a problem that could affect normal operation. "Warning Active" appears on the LCD to notify you of the warning condition. Normal operation continues until the warning condition:

- clears and normal operation continues
- escalates to a fault condition.

Fault messages indicate a fault condition. When a fault occurs, the solar charge controller:

- displays "Fault Active" on the LCD
- disables the MPPT and charging functions
- opens the relay that connects its power circuits to the battery bank.

The only fault that does not disable normal solar charge controller operation is the Auxiliary Output Overload Fault. The Auxiliary Output Overload Fault only disables the auxiliary output. Other solar charge controller functions continue operating. The Ground Fault disables the auxiliary output as well as normal solar charge controller operation.

Most warnings and faults clear automatically once the condition that caused them goes away. The only exceptions are the Auxiliary Output Overload Fault and the Ground Fault. The Auxiliary Output Overload Fault must be cleared manually. The Ground Fault requires you to correct the ground fault and restart the system. For more information, see Troubleshooting.

To view the complete list of active faults and warnings:

1. Press Enter on the Active Faults and Warning Menu screen.
2. Press the down button to view additional fault or warning messages.
If there are no active faults and warnings, no messages are displayed after you press Enter from the Active Faults and Warnings screen.

To manually clear a fault:

1. Identify the active fault from the Active Faults and Warning Menu.
The two faults you can manually clear are "Batt Under Volt" (except when the battery voltage has fallen below 10 V) and "Aux Output Ovlid." and See Table 4-6 for descriptions of these faults.
2. Press Exit to return to the Active Faults and Warnings Menu, then press the down arrow to view the Clear Fault screen.
"Batt Under Volt" is displayed first.
3. Press Enter to view the cursor.

4. Press Enter again to clear the “Batt Under Volt” fault.
Or
Press the down arrow to select the “Aux Output Ovld” fault, then Enter to clear it.

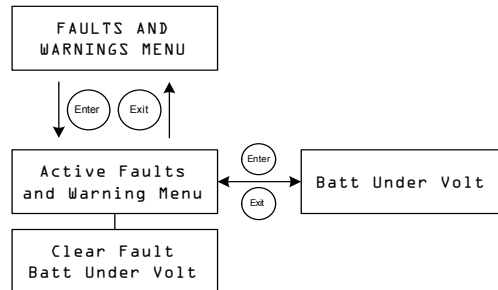

Figure 4-3 Faults and Warnings Menu

Table 4-6 Fault and Warning Messages

Display	Description
Input Over Voltage Warning	During operation, the solar charge controller continuously monitors the input voltage. If the voltage exceeds 137 VDC (± 1 V) for one second, the solar charge controller displays an Input Over Voltage Warning. The warning clears itself when the voltage falls to 134 VDC for 1 second.
Input Over Voltage Fault	During operation, the solar charge controller continuously monitors the input voltage. If the voltage exceeds 142 VDC (± 1 V), the solar charge controller instantly registers an Input Over Voltage Fault. The detection circuitry is faster than breakers or fuses, and they will not trip or blow when a fault occurs. The fault clears itself when the voltage falls to 140 VDC for 5 seconds.
Battery Over Voltage Fault	<p>Battery Over Voltage Fault appears when the battery voltage becomes abnormally high and the solar charge controller stops charging to protect the batteries. The fault occurs when battery voltage rises above the nominal voltage plus:</p> <ul style="list-style-type: none"> • 4.5 V per 12 V (for example, above 33 V in a 24 V system) for 1 second. • 5.5 V per 12 V for 20 milliseconds. <p>The fault clears when battery voltage falls to the nominal voltage plus 3.5 V per 12 V for 10 seconds.</p>

Table 4-6 Fault and Warning Messages

Display	Description
Batt Under Volt	<p>The Batt Under Volt (Battery Under Voltage) Fault appears when the battery voltage falls to the nominal battery voltage, minus 4 V per 12 V (for example, below 32 V in a 48 V system) for 1 second. The fault clears when battery voltage rises to the nominal battery voltage, minus 3 V per 12 V for 2 seconds. You can also clear this fault manually, except when battery voltage falls below the minimum solar charge controller operating voltage of 10 V.</p> <p>The Battery Under Voltage fault notifies you if the solar charge controller is configured with the incorrect battery voltage.</p> <p>If this fault appears, check that the Battery Voltage setting is correct for your system. If the Battery Voltage setting is incorrect, correct the setting under the Battery Menu. When battery voltage is set properly, the fault will clear itself.</p> <p>If the Battery Voltage setting is already correct, then the batteries are excessively discharged. In this case, you can manually clear the fault and let the solar charge controller charge the batteries when sufficient solar power is available. You can also shut off any loads connected to the system and charge the batteries with another charger.</p>
Output Over Current Fault	<p>Output Over Current Fault appears when the output current rises above approximately 90 A.</p> <p>The fault clears when output current falls below 5 A for three seconds.</p>
Unit Over Temperature Flt	<p>The solar charge controller monitors its internal temperatures to protect components from high temperature damage. If the internal temperatures rise above 203 °F (95 °C) while operating in Charge mode, the solar charge controller registers a fault and stops producing power. The fault clears when the internal temperature falls to 185 °F (85 °C) for at least 10 seconds.</p>
Battery Over Temperature Flt	<p>Battery Over Temp Fault appears when the battery temperature reaches 140 °F (60 °C). The fault clears when the battery temperature falls to 131 °F (55 °C).</p>
Battery Setup Conflict Fault	<p>Battery Setup Conflict Fault appears when you have configured:</p> <ul style="list-style-type: none"> • more than one charging device on the same battery bank with an inconsistent nominal battery voltage setting • an inconsistent battery type setting.

Table 4-6 Fault and Warning Messages

Display	Description
Aux Output Ovl	Auxiliary Output Overload Fault. This fault appears when too much current is being drawn from the auxiliary output. The fault triggers when the auxiliary output voltage falls more than 1 V below the auxiliary output voltage for three seconds.
Ground Fault	Ground Fault appears when a ground fault causes the ground fault protection (GFP) fuse to blow. The Ground Fault message clears after system power is removed, the ground fault is corrected, the GFP fuse is replaced, and system power is restored. See Chapter 5, "Troubleshooting".

Viewing Logged System Data

The solar charge controller stores accumulated operating data for viewing on the History menu. You can also reset some of the logged data on the History menu.

On the History Menu you can view logs for daily, monthly, or lifetime power production.

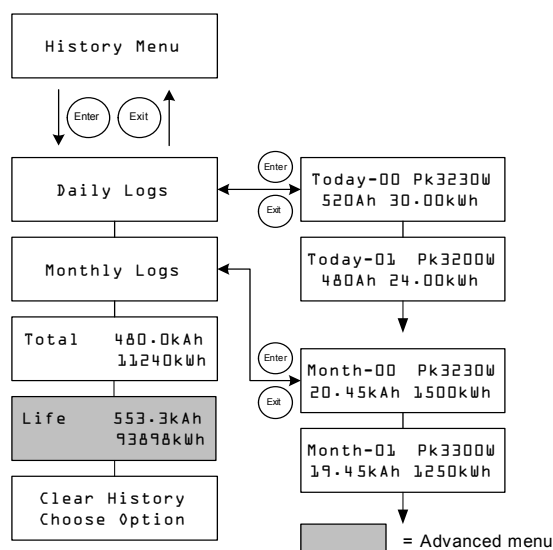

Figure 4-4 History Menu

Table 4-7 History Menu Items

Item	Description
Daily Logs	Press Enter to view the Daily logs (see page 4-14). Each Daily log contains the day's accumulated Watt-hours, Amp-hours, and the peak watts recorded that day.
Monthly Logs	Press Enter to view the Monthly logs (see page 4-14). Each Monthly log contains 30 days of accumulated Watt-hours, Amp-hours, and the peak watts recorded during that 30-day period.
Total 480.0kAh 411240kWh	Displays the total Amp-hours and kilowatt-hours produced since the last screen reset. You can reset these totals by selecting Total on the Clear History screen.
Life 553.3kAh 93898kWh	Displays the total kilo-amp-hours and kilowatt-hours produced since installation. These totals cannot be reset.
Clear History Choose Option	Resets logged information to zero. Options available are Daily Logs, Monthly Logs, Total, All. You can clear all the daily logs and all monthly logs. You cannot clear logs for individual days and months.

Daily Logs

To view the daily logs stored in memory, press Enter from the Daily Logs screen, then press the down arrow button to view each log, starting with the most recent. On the log screen, the current day is “Today-00,” yesterday is “Today-01,” and so on. See Figure 4-4.

The solar charge controller stores up to 30 daily logs. After 30 days, the oldest daily log is overwritten with the newest log.

After logging 30 daily logs, the solar charge controller totals the collected data and creates a new monthly log.

Monthly Logs

To view the monthly logs stored in memory, press Enter from the Monthly Logs screen, then press the down arrow button to view each log, starting with the current month. On the log screen, the current month is “Month-00,” the previous month is “Month-01,” and so on. See Figure 4-4.

Monthly logs consist of the total data from the previous 30 daily logs. To the solar charge controller, a “month” is a 30-day period, and does not match the months of the calendar.

The solar charge controller stores up to 12 monthly logs. After 12 months the oldest monthly log is overwritten with the newest log.

Battery Equalization

Equalization charging is the process of deliberately charging a battery (or battery bank) at a high voltage for a set period of time. Equalize charging remixes the electrolyte, helps to remove sulfate buildup on the battery plates, and balances the charge of individual cells.

Be sure to read all cautions and warnings regarding equalization charging batteries before allowing an equalization charge to occur.

Important: The solar charge controller maximum output voltage is limited to 72 V for a 60 V battery system, and so is unable to equalize a 60 V battery system.

Important: In a system where more than one device is capable of equalizing batteries (such as a system including multiple solar charge controllers and XW Inverter/Chargers), there is no system-wide equalization command for all devices. To equalize with multiple devices, each would have to be enabled individually. Alternatively, equalization can be performed using only one device. During the equalization process, one device applies the equalization charge while the other devices continue to operate in synchronized charge mode, typically in float (three-stage charging) or no-float (two-stage charging).

⚠ WARNING**EXPLOSIVE GASES**

Equalization generates explosive gases. Ensure adequate ventilation.

⚠ CAUTION**BATTERIES MAY BE DAMAGED**

Never equalize a battery more than necessary. Equalization can damage your batteries if performed too frequently or done improperly. Always check electrolyte level before *and* after equalization. Fill with distilled water according to the battery manufacturer's recommendation.

The solar charge controller enables equalization only when the battery type is set to "Flooded." Equalize mode is disabled if you have selected "GEL" and "AGM" as the battery type. As a general rule, do not equalize a battery unless there are provisions to add water to it and the manufacturer recommends equalization.

⚠ CAUTION**RISK OF DAMAGE TO DC LOAD EQUIPMENT**

The equalization voltage significantly exceeds the nominal voltage of the battery. Disconnect sensitive loads from the battery before equalizing.

Follow the battery manufacturer's recommendations for equalizing your batteries. As a guide, a heavily used flooded battery may need to be equalized once a month, and a battery in light service may only need to be equalized every two to four months.

You can set an equalization reminder on the Battery Menu. See page 3–6.

The equalization process lasts for one hour. When the equalization period had finished, the Charge Controller will return to either the float or no float charge stage.

To manually begin battery equalization:

1. From the Battery Menu screen, press Enter.
2. On the Equalize screen, select Activate.

If the battery is in the float or no float stage, the solar charge controller goes back to the bulk stage and goes through a full charge cycle before entering the Equalization stage. The LCD displays "Equalization Pending" while the solar charge controller performs this full charge cycle. The full charge cycle ensures that the batteries are fully charged before an equalization is attempted.

The Operating screen appears, indicating how much time, in minutes and seconds, remains in the equalization process.

The solar charge controller applies the equalization charge for one hour. You can also stop the equalization process manually.

If conditions prevent the PV array from producing enough power for the solar charge controller to provide an equalization charge, the equalization timer continues running. If conditions continue to make it difficult to complete a full equalization charge, use another device, such as an inverter/charger, to perform battery equalization.

To manually stop battery equalization:

1. From the Battery Menu screen, press Enter.
2. On the Equalize screen, select Stop.

Equalization stops, and the solar charge controller goes to either the Float or No Float stage, depending on the charge mode selected.

5

Troubleshooting

Chapter 5 contains information about identifying and resolving possible problems with systems using a Conext MPPT Solar Charge Controller.

It includes:

- PV Charge Control Troubleshooting
- Replacing the Ground Fault Protection Fuse

PV Charge Control Troubleshooting

Table 5-1 lists possible problems that may arise when using the Conext MPPT Solar Charge Controller (solar charge controller).

Table 5-1 PV Charge Control Problems

Problem	Possible Cause	Solution
The LCD shows “Low Light” under all conditions.	<p>PV wires are connected in reverse polarity.</p> <p>The PV input has short circuited and input voltage is zero volts.</p>	Verify PV polarity relative to battery negative.
Low panel output. Input and output voltages read about the same.	<p>Array maximum power point is less than the nominal battery voltage.</p> <p>The solar charge controller is still charging, but cannot charge at V_{MPP}</p>	Check or reconfigure the array.
Uneven output current between multiple solar charge controllers.	<p>A. Solar arrays are supplying different amounts of current to each charge controller.</p> <p>B. Charging set points are not all set the same.</p> <p>C. Excess voltage drop in wiring causing controllers to measure the battery voltage differently and regulate accordingly.</p> <p>D. Chargers are in Constant Voltage (absorption) mode and therefore are limiting their output current to maintain the present battery voltage. In this situation, some units will produce more output current than others.</p>	<p>A. Check array output, but consider that this could be a normal operating condition if the arrays are located in different locations and/or point in different directions.</p> <p>B. Set controllers to the same settings.</p> <p>C. Check wiring. Upgrading or shortening the wire run may be required.</p> <p>D. No need for intervention, as this is a normal operating condition.</p>

Table 5-1 PV Charge Control Problems

Problem	Possible Cause	Solution
Battery voltage is exceeding Bulk and Float settings in cold weather and not reaching settings in hot weather.	BTS is compensating charging voltages based on battery temperature.	No problem. This is the intended operation.
The LCD shows “Ground Fault” and the unit has stopped operating.	A ground fault has caused the ground fault protection (GFP) fuse to blow. A severe leakage between the PV array and earth ground has occurred.	See “Replacing the Ground Fault Protection Fuse”.

Replacing the Ground Fault Protection Fuse

⚠ WARNING

SHOCK AND FIRE HAZARD

Fuses should only be replaced by qualified service personnel, such as a certified electrician or technician. For continued protection against risk of fire, replace only with same type and ratings of fuse.

⚠ WARNING

SHOCK HAZARD

After disconnecting power from the solar charge controller, wait four minutes before attempting any maintenance or cleaning or working on any circuits connected to the unit. Internal capacitors remain charged for four minutes after disconnecting all sources of power.

⚠ WARNING

SHOCK HAZARD

- Dangerous voltages can exist inside the solar charge controller. If there is leakage current from the ungrounded conductor to ground at the array, touching the grounded lead could cause a life-threatening shock.
- Cover PV arrays with an opaque material during this procedure.

When the fuse has blown due to a fault, incorrect handling can be life-threatening. Use insulated tools.

The ground fault protection fuse blows when severe leakage occurs between the PV array and earth ground, or when the system has been installed with faulty wiring. Before replacing the fuse, it is important to have qualified service personnel, such as a certified electrician or technician, determine the cause of the ground fault.

To replace the ground fault protection fuse:

1. Remove the wiring compartment cover, as described on page 2–6.
The ground fault protection fuse is located behind the wiring terminals.
2. Remove the blown fuse and replace it with a new AC/DC midget cartridge, rated 600 Vdc, 1A (Littelfuse KLKD 1 or equivalent). Be careful not to damage the fuse clips, circuit board and surrounding components.
3. Replace the wiring compartment cover.

A

Specifications

Appendix A provides the specifications for the Conext MPPT Solar Charge Controller.

It includes:

- Electrical Specifications
- Default Battery Charging
- Mechanical Specifications
- Output Power Versus Ambient Temperature
- Optional Accessories
- Regulatory Approvals

All specifications are subject to change without notice.

Electrical Specifications

Maximum PV Array Voltage (Operating)	140 VDC
Maximum PV Array Open Circuit Voltage	150 VDC
Array Short Circuit Current	60 ADC maximum
Nominal Battery Voltage	12, 24, 36, 48, 60 VDC
Battery Voltage Range (Operating)	10 VDC to 80 VDC
Maximum Output Current	60 A (for all battery voltages except 60 V)
Maximum Output Power	3500 W
Auxiliary Output	5–13 V, up to 200 mA
Tare Loss/Night-time Power Consumption	2.5 W
Charger Regulation Method	Three-stage (bulk, absorption, float) Two-stage (bulk, absorption)

Default Battery Charging Settings

All settings in the following table are based on a 12-volt nominal battery bank. For the other nominal voltages, scale the values in this table appropriately (48-volt systems would use voltages four times that of the values listed in this table). An exception to this is for equalize voltage on a 60-volt system. The maximum programmable output voltage is 72 volts, but a 60-volt system would need to be equalized at 80 volts. Therefore, the maximum equalize voltage is limited to 72 volts on a 60-volt system.

Setting	Battery Type		
	Flooded ^a	Gel	AGM
Equalize Voltage	16.0 V	n/a	n/a
ReCharge Voltage	12.5 V	12.5 V	12.5 V
Bulk Voltage	14.4 V	14.2 V	14.3 V
Absorption Voltage	14.4 V	14.2 V	14.3 V
Float Voltage	13.5 V	13.8 V	13.4 V
Absorption Time	180 min	180 min	180 min
Batt Temp Comp	-27m V/C	-27m V/C	-21m V/C

a. When a Custom battery type is selected, the default settings are based on the Flooded battery type.

Mechanical Specifications

Enclosure Type	Indoor, ventilated, sheet metal chassis with $\frac{7}{8}$ " and 1" (22.22 mm and 27.76 mm) knockouts and aluminum heat sink
Maximum and Minimum Wire Size in Conduit	#6 AWG to #14 AWG (16 to 2.5 mm ²)
Maximum and Minimum Wire Size Rating of Terminal Block	#3 AWG to #14 AWG (25 to 2.5 mm ²)
Operating Temperature Range (full power)	-4 to 113°F (-20 to +45°C)
Storage Temperature	-40 to 185°F (-40 to +85°C)
Pollution degree	2
Over voltage category	CAT II
Altitude Limit (operating)	Sea level to 15,000 feet (4572 m) @ 15°C
Dimensions (H x W x D)	14 ½ x 5 ¾ x 5 ½" (368 x 146 x 138 mm)
Mounting	Vertical wall mount
Weight (Controller only)	10.75 lb (4.8 kg)
Weight (Shipping)	13.75 lb (6.2 kg)

Output Power Versus Ambient Temperature

Once the charge controller heat sink reaches maximum full-power operating temperature, the unit reduces its power output to ensure component ratings are not exceeded.

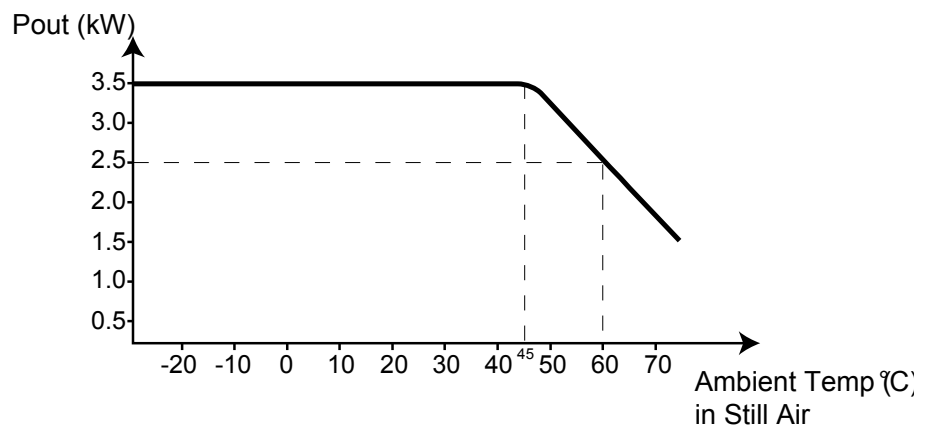

Figure A-1 Output Power vs. Ambient Temperature

Optional Accessories

Conext System Control Panel	865-1050
Conext Automatic Generator Start	865-1060
Network cables	3 ft (0.9 m): 809-0935
	25 ft (7.6 m): 809-0940
	50 ft (15.2 m): 809-0941
	75 ft (22.9 m): 809-0942
Network terminators	Male (2 per pack): 809-0901

Regulatory Approvals

Certified to UL 1741:2005 and to CSA 107.1-01 and carries the c(CSA)us mark.

EMC - North America:

- FCC Part-15 sub part B, Class B
- Industry Canada ICES-003, Class B

CE Marked and complies with the following:

Low Voltage Directive 73/23/EEC, per:

- EN50178 "Electronic Equipment for Use in Power Installations".

EMC Directive 2004/108/EC, per:

- EN61000-6-3 "Emission Standard for Residential, Commercial, and Light-Industrial Environments"
- EN61000-6-1 "Immunity for Residential, Commercial, and Light-Industrial Environments"

Australia

- C-tick marked

B

Conext System Control Panel Menus

Appendix B is a guide to the Conext System Control Panel monitoring and configuration menus for the Conext Solar Charge Controller.

It includes:

- Using the SCP
- SCP Menu Map
- Changing Settings Using the SCP
- Charge Controller Setup Menu
- Configuration Settings
- Monitoring the Charge Controller

The Conext System Control Panel may be installed if the solar charge controller is part of a system that includes an Conext XW+ inverter/charger.

Using the SCP

The Conext Solar Charge Controller (charge controller) can be configured using the Conext System Control Panel (SCP). If you do not have a SCP installed, all configuration items described in this appendix are also available from the charge controller LCD front panel. See the Chapter 3, “Configuration” for more information.

The SCP has four buttons for navigating between screens and menus and configuring the solar charge controller. See Figure B-1 and Table B-1.

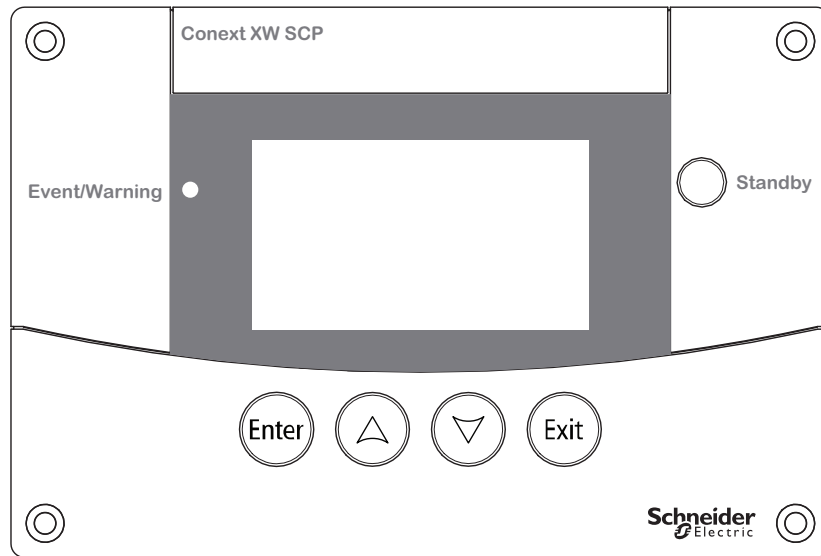





Figure B-1 Conext System Control Panel

Table B-1 Conext System Control Panel Navigation Buttons

Button	Function
	<ul style="list-style-type: none"> • Confirms selection of a menu item • Displays the next screen
	<ul style="list-style-type: none"> • Scrolls up one line of text • Increases a selected value • Displays the previous Device Home screen
	<ul style="list-style-type: none"> • Scrolls down one line of text • Decreases a selected value • Displays the next Device Home screen
	<ul style="list-style-type: none"> • Cancels selection of a menu item • Displays the previous screen

SCP Menu Map

Figure B-2 shows how the SCP screens and menus are organized. The screens and menus are described in Table B-2.

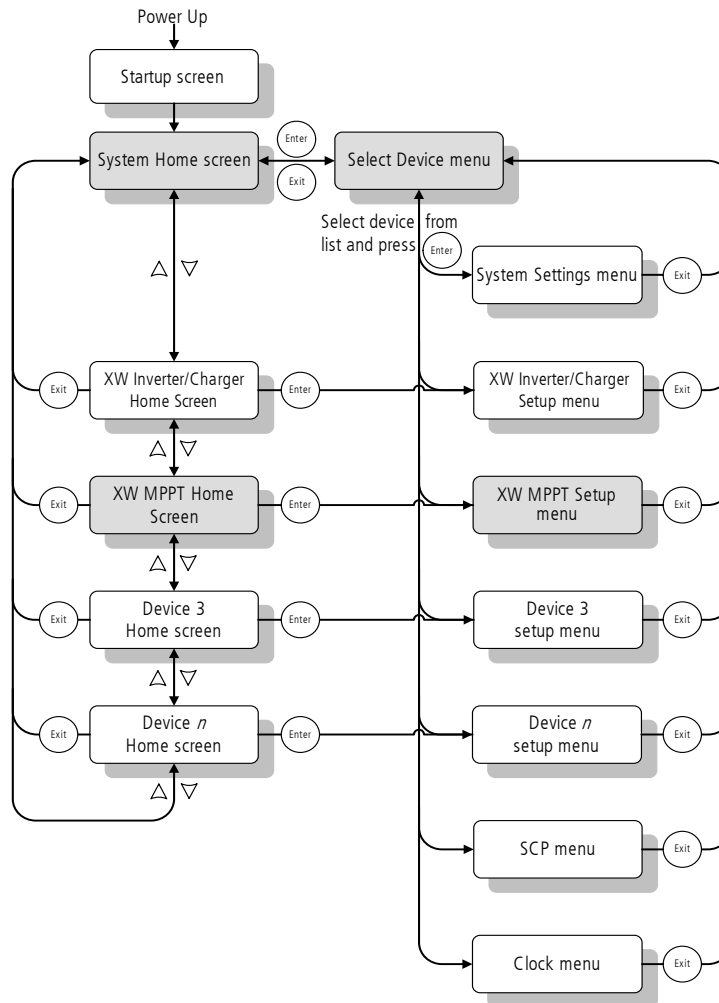

Figure B-2 Conext-MPPT60-150 Menu Map

Table B-2 Screen and menu descriptions

Screen or menu	Description
Startup screen	Appears for a few seconds after the system starts up or when the system has been reset.
System Home screen	Displays status information for the power system, consisting of all Xanbus-connected devices on a single network. The System Home screen appearance varies with the status of the inverter/charger and other Xanbus-enabled devices in the power system. The System Home screen always features a "Menu" arrow pointing to the Enter button. Pressing Enter takes you to the Select Device menu.
XW MPPT Home screen	Displays status information for the solar charge controller.
Select Device menu	Displays a list of Xanbus-enabled devices in the system, including the solar charge controller and the SCP. The length of this menu depends on how many Xanbus-enabled devices are installed in the system. This menu also contains the clock menu (where you can set the time and date) and the system settings menu (where you can change system modes). The System Panel, Clock, and System Settings menus are always available from the Select Device menu, regardless of the number of Xanbus-enabled devices installed.
XW MPPT Setup menu	Displays status information and changeable settings. Changeable settings are identified by the square brackets [] around values in the right-hand column.

Changing Settings Using the SCP

If you need to change a solar charge controller setting, use the buttons on the SCP to perform three basic steps:

1. View the Select Device menu.
2. Select the solar charge controller from the Select Device menu.
3. Select and adjust a changeable setting on the solar charge controller Setup menu. See page B-8.

Each of these three steps is described in detail in the following sections.

Note: You can also view the solar charge controller Setup menu by pressing Enter from the solar charge controller Home screen. See “Charge Controller Home Screen” on page B-10.

Viewing the Select Device Menu

The Select Device menu is where you select a Xanbus-enabled device to monitor or configure. The number of items on the Select Device menu depends on how many devices are installed in your Xanbus system.

To view the Select Device menu:

- ◆ On the System Home screen, press Enter.

Important: You can always identify the System Home screen by the menu arrow in the bottom left corner of the screen. The menu arrow indicates the Enter button on the System Control Panel, which you press to view the Select Device menu.

Viewing the solar charge controller Setup Menu

On the Select Device menu, select the solar charge controller to view and change its settings.

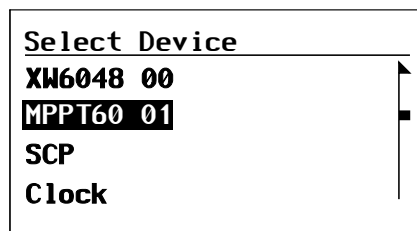

Figure B-3 Selecting the solar charge controller

To select the solar charge controller from the Select Device menu:

1. On the Select Device menu, use the down arrow button to highlight MPPT60 150.
2. Press Enter. The Setup menu appears.

Charge Controller Setup Menu

The Setup menu allows access to the Meters screen and several other commands that control solar charge controller operation.

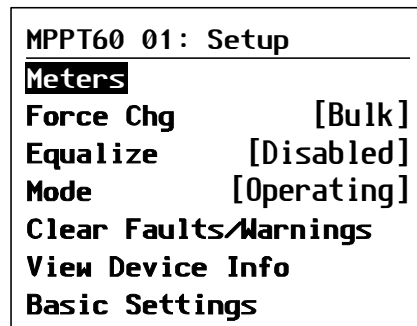

Figure B-4 Charge Controller Setup Menu

Table B-3 Charge Controller Setup Menu

Menu Item	Description
Meters	Displays the Meters screen.
Force Chg	Causes the current charge stage to change to the selected stage.
Equalize	Starts or stops battery equalization.
Mode	Selects the solar charge controller operating mode: Operating or Standby.
Clear Faults/ Warnings	Clears any active faults or warnings. If the fault or warning condition is still present, the fault or warning message may reappear.
View Device Info	Displays the Device Info screen. On the Device Info screen you can view the Warning Log, Fault Log and Event Log.
Basic Settings	Displays the solar charge controller Basic or Advanced configuration settings (to change to Advanced Settings, press Enter + up arrow + down arrow).

Configuration Settings

Basic menu

The configuration settings can be viewed in Basic and Advanced formats (see Figure 3-5, “Basic and Advanced Settings” on page 3–8). The Basic settings include configuration items you may have to adjust routinely, or as part of initial setup.

Advanced menu

The Advanced settings option gives you access to the full range of settings, including everything displayed on the Basic menu. As a safeguard against unintended advanced configuration, the Basic settings are displayed by default. To enable the Conext Conext-MPPT60-150 to display the Advanced settings, you must perform a special keypress. To enable the Advanced menu:

- ◆ Press the Enter + up arrow + down arrow buttons simultaneously.

The “Basic Settings” item changes to “Advanced Settings.”

After configuring the Charge Controller, to prevent unintended advanced configuration, use this keypress again to hide the Advanced menu.

Important:

- This keypress displays Advanced settings for every device in the system.
 - After performing the keypress, “Advanced Settings” appears at the top of the Setup menu. When the keypress is performed again, the Setup menu displays “Basic Settings” as the last item on the menu.
-

The solar charge controller Configuration settings contain sub-menus for configuring:

- Multiple-unit operation
- Charger and battery settings
- Input settings
- Auxiliary output settings.

To view the Configuration settings:

- ◆ From the Setup menu, with Basic Settings or Advanced Settings highlighted, press Enter.

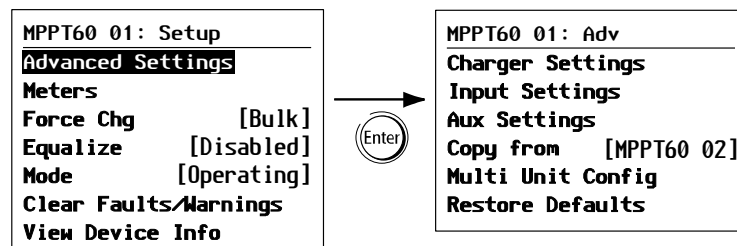

Figure B-5 Selecting the Configure Menu

For a map of all solar charge controller configuration menus, see Figure B-7 on page B-9.

Configurable settings are identified by the square brackets [] around the values along the right side of the screen.

To select and change a configurable setting:

1. On the desired configuration menu, press the up arrow or down arrow button to highlight the setting you want to change.
2. Press Enter to highlight the current value of the setting.
3. Press the up arrow or the down arrow button to change the value. Hold down the button to scroll through a large range of values quickly.
The previously set value appears with an asterisk (*) beside it.
4. Press Enter to select the value.
5. If you have another setting to change, return to step 1.

Or

If you have no more settings to change, press Exit until the SCP displays the desired screen or menu.

To restore solar charge controller default settings:

1. On the Configure menu, select Restore Defaults.
2. Press Enter.

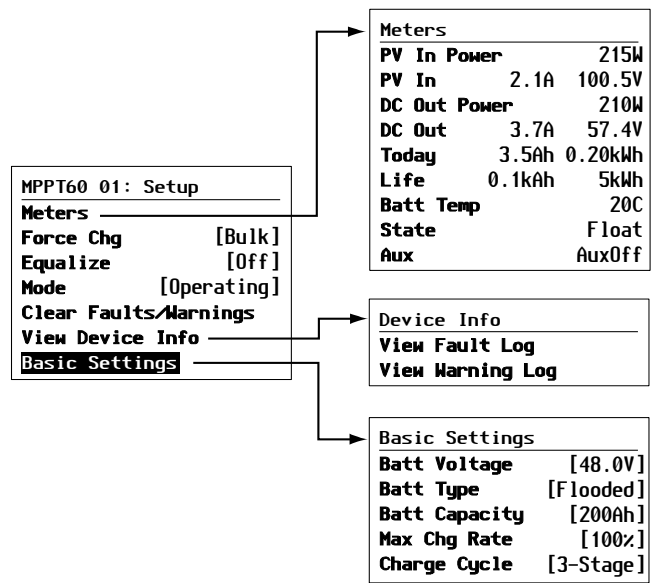

Figure B-6 Configuration Menus (Basic)

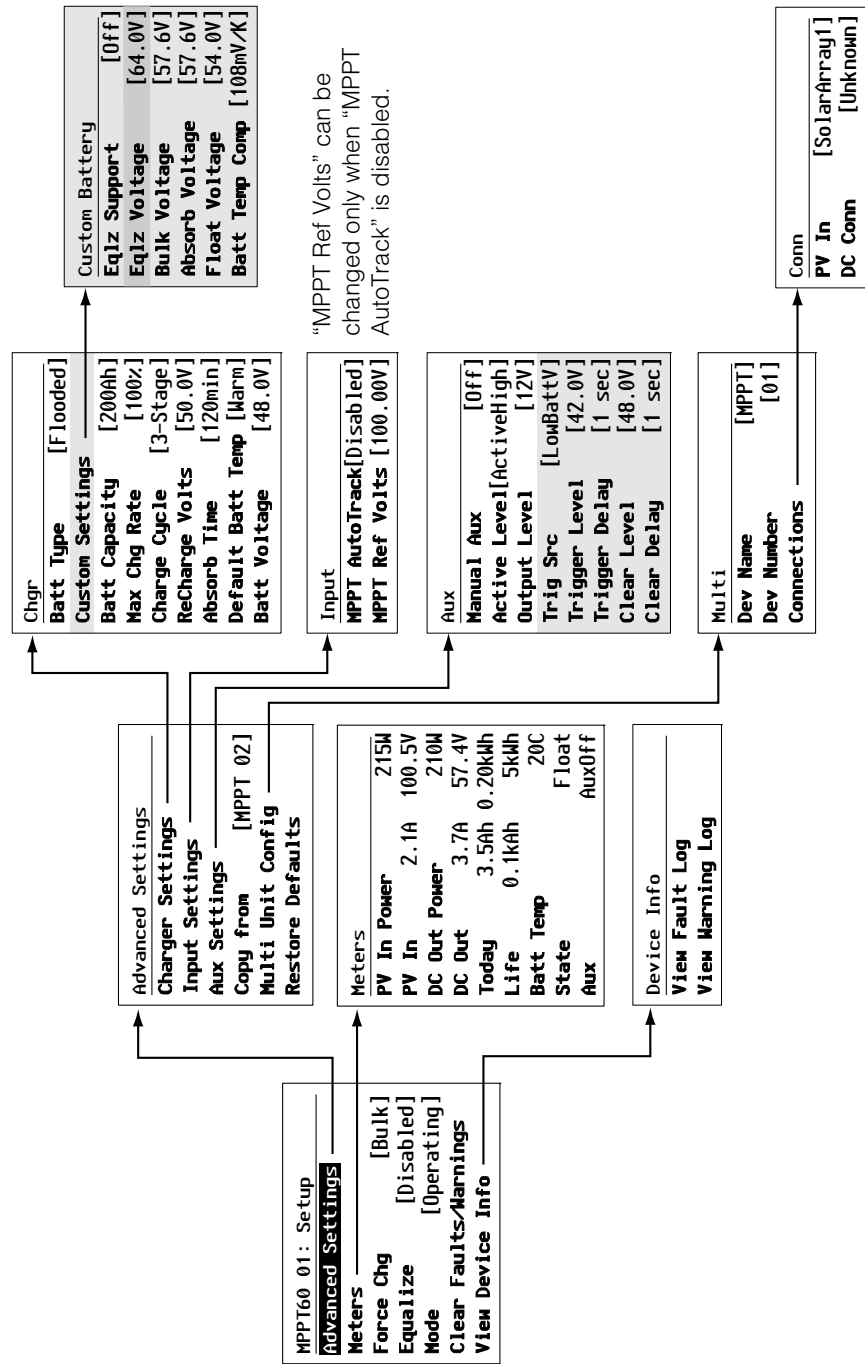

Figure B-7 Configuration Menus (Advanced)

Monitoring the Charge Controller

You can monitor solar charge controller operation on the SCP by viewing the:

- solar charge controller Home screen
- solar charge controller Meters screen

Charge Controller Home Screen

The solar charge controller Home screen displays real-time operational data specific to the solar charge controller.

To view the solar charge controller Home screen:

- ◆ From the System Home screen, press the down arrow until the solar charge controller Home screen appears.

To return to the System Home screen:

- ◆ Press the Exit button, as indicated by the “system” arrow on the solar charge controller Home screen.

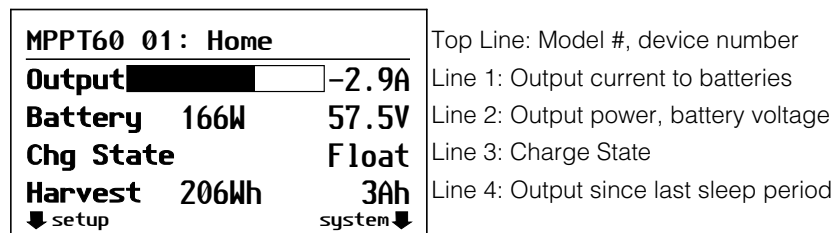

Figure B-8 Charge Controller Home Screen

The solar charge controller Home screen features a “setup” arrow pointing to the Enter button and a “system” arrow pointing to the Exit button. Pressing Enter takes you to the solar charge controller Setup menu. Pressing Exit takes you to the System Home screen.

Pressing the down arrow button takes you to the Home screens for the other Xanbus-enabled devices in the system.

Meters

You can monitor solar charge controller operation on the Meters screen. The Meters screen displays input and output power, battery temperature, charge stage, and total power production for that day and power production over the unit's lifetime.

You can select the Meters screen from the solar charge controller Setup menu.

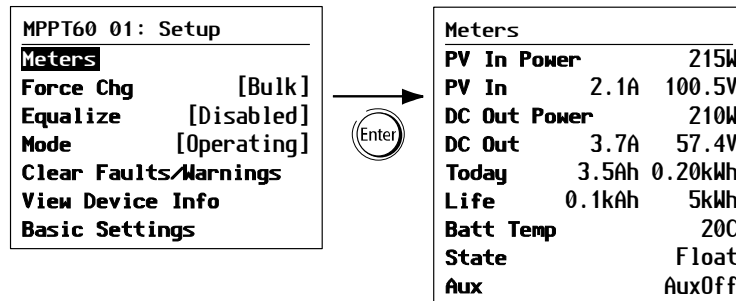

Figure B-9 Selecting the Meters Screen

C

Boost Charging

Appendix C provides information on boost charging for flooded lead-acid batteries in off-grid applications.

Using Boost Charging

Boost charging allows for better utilization of flooded lead acid batteries under moderate cycling in off grid applications. Boost charging encourages a short duration charging voltage—above the gassing voltage—at the beginning of the absorption charge state. Testing has shown that boost charging improves battery performance by providing a regular mixing of the liquid electrolyte. Boost charging specifically discourages capacity-robbing acid stratification and plate sulfation.

Boost mode charging can be enabled by selecting 'custom' battery type and by setting the bulk voltage higher than the absorption voltage. The multi-stage charge algorithm then attempts to use the higher bulk voltage for the first hour of the absorption stage—unless interrupted by the max absorption timer or exit current threshold.

1. Boost charging encourages gassing of flooded lead acid batteries.

⚠ WARNING
EXPLOSIVE GASES
Always ensure adequate battery ventilation.

2. Boost charging is NOT recommended for AGM, GEL or any other electrolyte-limited and/or valve regulated sealed battery application.
3. Boost charging may result in higher-than-normal water consumption. However, the benefits of boost charging are likely to be greater than the extra watering effort. Check battery water levels at least once per month.
4. Boost charging has maximum benefit when used on batteries that experience moderate cycling. An unoccupied cottage, for example, where batteries are full the majority of the time, may not benefit from boost charging - especially if battery watering is difficult.

Index

A

- abbreviations iv
- absorption charging stage 1–5
- acronyms iv
- advanced menus 3–3
- alarms using auxiliary output 1–10
- auxiliary output functions 1–10
- auxiliary output menu 3–12

B

- basic menus 3–3
- battery equalization 4–14
- battery menu 3–5
- battery safety information vii
- battery temperature compensation 1–9, 3–10
- bulk charging stage 1–5

C

- CAUTION, definition v
- charge stages 1–5, 4–6
- communication between multiple inverters 2–25
- Conext System Control Panel
 - down arrow button B–2
 - enter button B–2
 - exit button B–2
 - up arrow button B–2
- current rating 2–15
- custom battery menu 3–8

D

- daily logs 4–13
- DANGER, definition v
- default settings, resetting to 3–20, B–8
- device menu 3–18
- display menu 3–16
- down arrow button 3–2
- down arrow button, Conext System Control Panel B–2

E

- enter button 3–2
- enter button, Conext System Control Panel B–2
- equalization
 - definition 1–9
 - manual 4–15

- recommended frequency 4–15
- exit button 3–2
 - Conext System Control Panel B–2

F

- faults and warnings menu 4–9
- float charging stage 1–5

G

- ground fault protection fuse
 - replacing 5–4
- grounding 2–9

H

- history menu 4–13

I

- Information about Your System form 1–ii
- input menu 3–11
- inverter
 - purchase date 1–ii
 - serial number 1–ii

K

- knockouts
 - locations and dimensions 2–7
 - removing 2–6

L

- LCD operating screens 4–2
- load control 1–10
- logged operating data 4–13

M

- menu maps 3–4, B–8, B–9
- menus, basic and advanced formats 3–3
- meters screen B–11
- monthly logs 4–13
- multiple inverters
 - communication between 2–25

N

- NOTICE, definition v

P

parallel configuration
 communication between inverters 2–25
proof of purchase 1–ii
purchase date 1–ii

R

reset menu 3–20
restore default settings B–8

S

serial number 1–ii
silent float charging stage 1–7
system control panel
 buttons described B–2
 changing settings B–5
 charge controller home screen B–10
 meters screen B–11
 select device menu B–4, B–5
 startup screen B–4
 system home screen B–4

T

three-stage charging 1–5
Troubleshooting 5–2
two-stage charging 1–7

U

up arrow button 3–2
up arrow button, Conext System Control Panel B–2

V

vent fan 1–10

W

WARNING, definition v
wire size 2–14

Schneider Electric

solar.schneider-electric.com

As standards, specifications, and designs change from time to time, please ask for confirmation of the information given in this publication.

© 2015 Schneider Electric. All rights reserved.

975-0400-01-01 Revision G

Printed in China